

CoDyBA BESTEST Qualification

Jean NOËL



Jean NOËL (JNSOFT)
Free-Lance Engineer
15 place Carnot
69002 Lyon
France

February 2004

Abstract

The present report describes the BESTEST reference cases and the results obtained with CoDyBa software.

CoDyBa is a software used to determinate the heat flows in a building. CoDyBa is specially oriented toward optimisation of energy performance in buildings.

In order to validate this software, its results are compared to results given by other reference programs, on some test cases defined in the international standard BESTEST (IEA 1995).

These tests treat many typical situations encountered in building construction. The geometry concerns a heavyweight and a lightweight room located at Denver (USA). This room contains heating and cooling systems in some cases. Cases with and without windows are treated. Sun shading is also introduced.

Detailed results are annual heating and cooling loads, peaks of heating and cooling loads. Extremes reached values are given, when free temperature evolution is allowed.

A very good agreement is found : results are presented, which show that CoDyBa passed successfully through qualification test cases.

Acknowledgements

The author is very grateful to Pr Jean-Jacques ROUX for the general assistance that he brought to him in the realisation of this work.

Jean-Jacques ROUX

INSA de Lyon - Bât. Freyssinet
40 avenue des Arts
69100 Villeurbanne
France

Table of contents

I - INTRODUCTION	6
I - 1 - WHAT BESTEST IS.....	6
I - 2 - WHAT CoDyBa IS.....	6
II - BESTEST OVERVIEW	6
II - 1 - BACKGROUND.....	6
II - 2 - SOME REMARKS ON VALIDATION METHODOLOGY.....	7
II - 3 - REFERENCE PROGRAMS LIST.....	7
III - TESTS INPUT SPECIFICATIONS	8
III - 1 - TIME.....	8
III - 2 - WEATHER DATA.....	8
III - 3 - GEOMETRY.....	9
III - 4 - MATERIALS.....	10
III - 5 - SURFACES.....	10
III - 5 - 1 - Walls.....	10
III - 5 - 2 - Window.....	11
III - 5 - 3 - Convective surface coefficients.....	13
III - 6 - INFILTRATION AND INTERNAL LOAD.....	13
III - 6 - 1 - Infiltration.....	13
III - 6 - 2 - Internally generated heat.....	13
III - 6 - 3 - Mechanical system.....	14
IV - TESTS DESCRIPTION	15
IV - 1 - GENERAL CASES DESCRIPTION.....	15
IV - 2 - QUALIFICATION CASES DESCRIPTION.....	15
IV - 3 - TEST CASES SUMMARY.....	16
V - RESULTS	17
V - 1 - CoDyBa RESULTS IN TABULAR FORM.....	18
V - 1 - 1 - BESTEST and CoDyBa Results in tabular form.....	18
V - 1 - 2 - BESTEST and CoDyBa Delta Results.....	19
V - 1 - 3 - BESTEST and CoDyBa Results (Standard/Commercial Version).....	20
V - 2 - BESTEST QUALIFICATION CASES.....	21
V - 2 - 1 - BESTEST Qualification : Annual Incident Solar Radiation.....	21
V - 2 - 2 - BESTEST Qualification : Annual Transmitted Solrad Unshaded.....	22
V - 2 - 3 - BESTEST Qualification : Annual Transmitted Solrad Shaded.....	22
V - 2 - 4 - BESTEST Qualification : Annual Transmissivity Coefficient of Windows.....	23
V - 2 - 5 - BESTEST Qualification : Annual Overhang and Fin Shading Coefficients.....	23
V - 2 - 6 - BESTEST Qualification : Low Mass Building.....	24
V - 2 - 7 - BESTEST Qualification : High Mass Building.....	25
V - 2 - 8 - BESTEST Qualification : Free-Float Cases.....	26
V - 2 - 9 - BESTEST Qualification : Case 900FF.....	27
V - 2 - 10 - BESTEST Qualifications : Hourly Loads.....	31
V - 2 - 11 - BESTEST Qualifications : Case 900FF Annual Hourly Temperature Frequency.....	32
V - 3 - BESTEST DIAGNOSTICS CASES.....	33
VI - CONCLUSIONS	34
VI - 1 - CONCLUSIONS.....	34
VI - 2 - FINAL CONCLUSION.....	34
VII - BIBLIOGRAPHY	35
APPENDIX : SUMMARY OF VALIDATION PROCEDURE PROPOSED BY CEN PR EN13791	36

List of tables

TABLE A : REFERENCE PROGRAMS LIST	7
TABLE B : BESTEST WEATHER DATA	8
TABLE C : DATA OBTAINED FROM CoDyBa WEATHER FILE	8
FIGURE A : SOUTH UNSHADED WINDOW BUILDING	9
FIGURE B : SECTION OF SOUTH WINDOW OVERHANG	9
FIGURE C : EAST AND WEST WINDOW SHADING	9
TABLE D : MATERIALS SUMMARY	10
TABLE E : WALLS SUMMARY	10
TABLE F : WINDOW SUMMARY	11
TABLE G : GLASS DATA SUMMARY	11
TABLE H : DETAILED CONVECTIVE SURFACE COEFFICIENTS SUMMARY	13
TABLE I : CONVECTIVE SURFACE COEFFICIENTS SUMMARY	13
TABLE J : CONTROL STRATEGY SUMMARY	14
TABLE K : BESTEST CASES SUMMARY	16
TABLE L : DETAILED CoDyBa RESULTS (BESTEST GLASS DATA)	18
TABLE M : DETAILED CoDyBa DELTA RESULTS (BESTEST GLASS DATA)	19
TABLE N : DETAILED CoDyBa RESULTS (CoDyBa COMMERCIAL VERSION GLASS DATA)	20
TABLE O : ANNUAL INCIDENT SOLAR RADIATION	21
TABLE P : ANNUAL TRANSMITTED SOLRAD UNSHADED	22
TABLE Q : ANNUAL TRANSMITTED SOLRAD SHADED	22
TABLE R : ANNUAL TRANSMISSIVITY COEFFICIENT OF WINDOWS	23
TABLE S : ANNUAL OVERHANG AND FIN SHADING COEFFICIENTS	23
TABLE T : FREE-FLOAT TEMPERATURES	26
TABLE U : HOURLY INCIDENT SOLAR FLUX DENSITY	27
TABLE V : HOURLY FREE FLOAT TEMPERATURES	29
TABLE W : HOURLY LOADS	31

List of result figures

FIG. R1 : ANNUAL INCIDENT SOLAR RADIATION.....	21
FIG. R2 : ANNUAL TRANSMITTED SOLRAD UNSHADED	22
FIG. R3 : ANNUAL TRANSMITTED SOLRAD SHADED	22
FIG. R4 : ANNUAL TRANSMISSIVITY COEFFICIENT OF WINDOWS.....	23
FIG. R5 : ANNUAL OVERHANG AND FIN SHADING COEFFICIENTS	23
FIG. R6 : LOW MASS ANNUAL HEATING.....	24
FIG. R7 : LOW MASS ANNUAL COOLING.....	24
FIG. R8 : LOW MASS PEAK HEATING	24
FIG. R9 : LOW MASS PEAK COOLING	24
FIG. R10 : HIGH MASS ANNUAL HEATING.....	25
FIG. R11 : HIGH MASS ANNUAL COOLING.....	25
FIG. R12 : HIGH MASS PEAK HEATING	25
FIG. R13 : HIGH MASS PEAK COOLING	25
FIG. R14 : MAXIMUM HOURLY ANNUAL TEMPERATURE.....	26
FIG. R15 : MINIMUM HOURLY ANNUAL TEMPERATURE	26
FIG. R16 : AVERAGE HOURLY ANNUAL TEMPERATURE	26
FIG. R17 : INCIDENT SOLAR FLUX DENSITY, CLOUDY DAY, SOUTH SURFACE	28
FIG. R18 : INCIDENT SOLAR FLUX DENSITY, CLOUDY DAY, WEST SURFACE	28
FIG. R19 : INCIDENT SOLAR FLUX DENSITY, CLEAR DAY, SOUTH SURFACE	28
FIG. R20 : INCIDENT SOLAR FLUX DENSITY, CLEAR DAY, WEST SURFACE	28
FIG. R21 : CASE 600FF, CLEAR COLD DAY, HOURLY FREE-FLOAT TEMPERATURES	30
FIG. R22 : CASE 900FF, CLEAR COLD DAY, HOURLY FREE-FLOAT TEMPERATURES	30
FIG. R23 : CASE 650FF, CLEAR HOT DAY, HOURLY FREE-FLOAT TEMPERATURES	30
FIG. R24 : CASE 950FF, CLEAR HOT DAY, HOURLY FREE-FLOAT TEMPERATURES	30
FIG. R25 : CASE 600, CLEAR COLD DAY, HOURLY LOADS	31
FIG. R26 : CASE 900, CLEAR COLD DAY, HOURLY LOADS	31
FIG. R27 : HOURLY OCCURRENCES FOR EACH 1 °C BIN.....	32
FIG. R28 : ANNUAL HEATING	33
FIG. R29 : ANNUAL COOLING	33
FIG. R30 : PEAK HEATING.....	33
FIG. R31 : PEAK COOLING.....	33

I - Introduction

I - 1 - What BESTEST is

BESTEST (Building Energy Simulation TEST) is conducted by the International Energy Agency (IEA). BESTEST [BR] is a benchmark for building energy simulation programs. It's a comparative testing procedure for thermal building simulations applied to a simplified building envelope. These tests build upon each other and permit the evaluation of a range of features including thermal mass, direct solar gain windows, window-shading devices, generated heat, infiltration, deadband and setback thermostat control. The tests are built to permit a diagnostic if the program fails. These tests start with a basic structure, which is completed by adding windows, exterior shading, or by modifying the wall materials, etc.

I - 2 - What CoDyBa is

CoDyBa [CDB] is a software, jointly developed by the CETHIL (INSA-Lyon Thermal Center, [CET]) and a freelance engineer [JNS], without any state help. It is aimed for design offices, teaching and research organisms.

CoDyBa is a software used to determinate the heat flows in a building. It permits to estimate the instant heating or cooling powers needed to maintain a given set-point, or to calculate the interior temperatures when the heating or cooling system is insufficient. Humidity is treated in the same way.

The tool is aimed to conduct studies of heating and cooling strategy, air conditioning or ventilation options, insulating materials to be installed. The room occupancy is included. CoDyBa does not permit the study of the dynamic behaviour of a set of technological components : the main objective is to forecast the energy consumption and temperature evolution range.

CoDyBa runs on classical PC. The building is described accurately and the building description is given by the use of a graphical interface. CoDyBa is based on simply bricks assembled to form a complex building with its equipment. The assembly is conducted in a form to minimise data size and calculation time. The physical models of CodyBa are those commonly admitted, but numerical algorithms are specific.

II - BESTEST Overview

II - 1 - Background

Numerous software programs are available to simulate energy performance in buildings. But these programs often produce divergent results.

BESTEST was created to systematically compare whole-building energy software programs and diagnose the sources of prediction differences. Field trials of the method were conducted with a number of selected "reference" programs that represent the best state-of-the-art detailed simulation capability available in United States and Europe. These included BLAST, DOE2, ESP, SERIRES, S3PAS, TASE and TRNSYS. Also, several programs were tested later (CLIM2000, DEROB).

The method consists of a series of carefully specified test case buildings that progress from the extremely simple to the relatively realistic. The more realistic cases test the ability of the programs to model effects such as thermal mass, direct solar gain windows, window-shading devices, internally generated heat, infiltration, sun-spaces, earth coupling and deadband and setback thermostat control.

The collective experience of the members of the BESTEST experts group has shown that when a program exhibits major disagreement with the reference programs, the underlying cause is usually a bug, faulty algorithm, or documentation problem.

The field trials revealed a large amount of disagreement among the participating programs. The differences ranged from approximately 20 % to about 66 %.

An advantage of BESTEST is that a program is examined over a broad range of parametric interactions based on a variety of output types, minimising the possibility for concealment of problems by compensating errors. During the project, some bugs were found in the 8 building energy simulation programs (and corrected), and some of the bugs may well have been present for many years. This fact shows the interest of using BESTEST to validate simulation programs.

II - 2 - Some remarks on validation methodology

A program may be validate by [BR][S140] :

- Analytical verification (the output from a program is compared to the result from a known analytical solution)
- Empirical validation (in which calculated results from a program are compared to monitored data from a real experiment)
- Comparative testing (in which a program is compared to itself or to other program. This approach includes "sensitivity testing" and "intermodel comparisons")

But all these approaches pose the problem of the equations and algorithms of references. Indeed, one can imagine a program that would reproduce reality without the current assumptions of modelling related to the need for reduced the number of data and the computing time. One can then expect notable differences with the results provided by the current programs of references, without for as much this program "perfect" is invalid.

Note that a validated code does not necessarily represent the truth : it does represent a set of algorithms that have been shown to perform according to the current state of the art. However, they are representative of what is commonly accepted as the current state-of-the art in whole-building energy simulation. A program, which disagrees with the reference data in this report, may not be incorrect, but it does merit scrutiny [BR][S140].

However, BESTEST represents a fairly coarse filter which has been successful at trapping major errors, but which may not detect all minor problems ([BR] p. 2.56).

II - 3 - Reference programs list

The reference applications are listed in the next table (see BESTEST Report Table 2-1 and Table 2-3) :

Application	Implemented by	Availability
BLAST 3.0	National Renewable Energy Laboratory (NREL), U.S.A. Politecnico Torino, Italy	Public domain
DOE2.1D 14	National Renewable Energy Laboratory (NREL), USA	Public domain
ESP-RV8	De Montfort University, U.K	Research
SERIRES/ SUNCODE 5.7	National Renewable Energy Laboratory (NREL), U.S.A.	Public domain / Commercial
SERIRES 1.2	Building Research Establishment, U.K.	Public domain
S3PAS	University of Sevilla, Spain	Research
TASE	Tampere University, Finland	Research
TRNSYS 13.1	Building Research Establishment, U.K. Vrije Universiteit Brussels (VUB), Belgium	Commercial
DEROB	Lund Insitut of Technology, Sweden	Public domain / Research
CLIM2000	Electricité de France (EDF), France	Research

Table A : reference programs list

III - Tests input specifications

III - 1 - Time

All references to time in this specification are to solar time, and assume that hour 1 = the interval from midnight to 1 a.m.

III - 2 - Weather data

The weather characteristics are summarised in Table B (see BESTEST report Table 1-3) :

Latitude	39.8° north
Longitude	104.9 west
Altitude	1609
Mean annual wind speed	4.02 m/s
Maximum annual wind speed	14.89 m/s
Ground reflectivity	0.2
Ground temperature	10 °C
Mean annual ambient dry-bulb temperature	9.71 °C
Minimum annual ambient dry-bulb temperature	-24.39 °C
Maximum annual ambient dry-bulb temperature	35 °C
Heating degree days (base 18.3 °C)	3636.2 °C-days
Cooling degree days (base 18.3 °C)	487.1 °C-days
Annual total global horizontal solar radiation	1831.82 kWh/m ² -year
Annual total direct normal solar radiation	2353.58 kWh/m ² -year
Direct horizontal solar radiation	1339.48 kWh/m ² -year
Diffuse horizontal solar radiation	492.34 kWh/m ² -year

Table B : BESTEST weather data

The hourly weather is characterized as "cold clear winters/hot dry summers".

The given weather file is converted to CoDyBa format. The latitude (40 °) is used during the conversion to get azimuth and height of the sun position.

In order to verify the weather file conversion, the following mean values are calculated from the CoDyBa weather file (see Table C) :

Average dry-bulb temperature	9.71 °C
Mini dry-bulb temperature	- 24. 39 °C
Maxi dry-bulb temperature	35 °C
Heating degree days (base 18.3 °C)	3636 °C-days
Direct horizontal solar radiation (integration of direct horizontal solar radiation over a year)	1339 kWh/m ² - year
Diffuse horizontal solar radiation (integration of diffuse horizontal solar radiation over a year)	492 kWh/m ² - year
Annual total global horizontal solar radiation (cumulative total of direct and diffuse horizontal solar radiation over a year)	1832 kWh/m ² -year

Table C : data obtained from CoDyBa weather file

The sky model used in CoDyBa supposes that the diffuse radiation density is constant for all angles (isotropic sky model for diffuse insulation).

The meteorological file gave no information about the sky temperature, so the following relation is applied:

$$T_{\text{Sky}} = T_{\text{Exterior}}$$

III - 3 - Geometry

The basic geometry of the test case building is a rectangular single zone with no interior partitions, with one or two window facing the south (see BESTEST Report Figures 1-3, 1-4, 1-5, 1-6) :

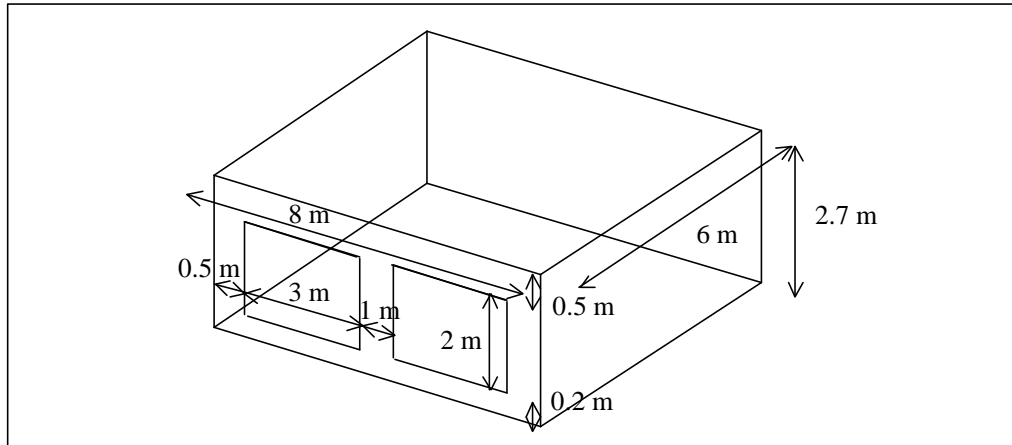

Figure A : south unshaded window building

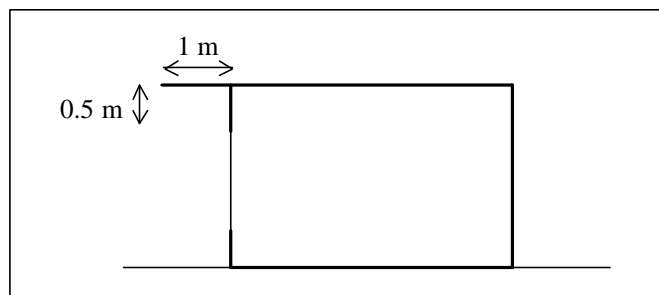

Figure B : section of south window overhang

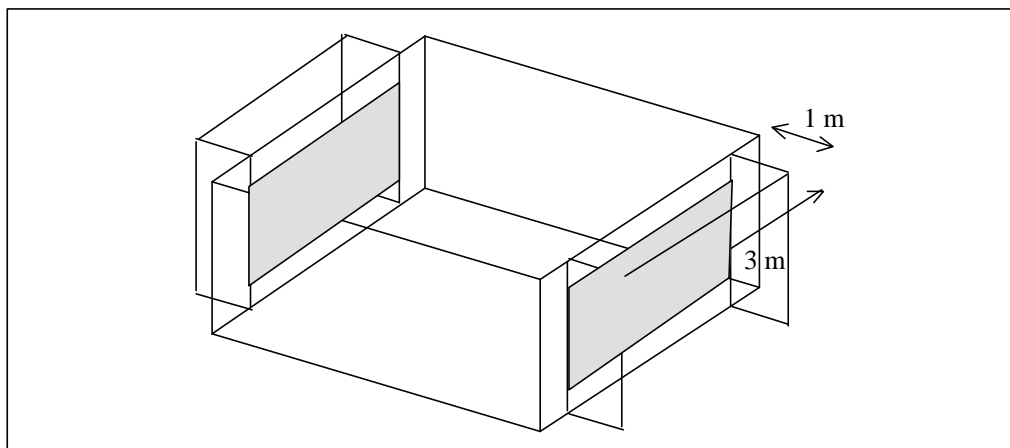

Figure C : east and west window shading

BESTEST recommend to include the shading effect on adjacent opaque surface, and also modifications to long wave interchange due to the shading device. But CoDyBa has not these capabilities.

III - 4 - Materials

Properties of used materials are detailed in Table D.

Materials	Conductivity (W/m ² /K)	Density (kg/m ³)	Specific heat (J/kg.°C)
Plasterboard	0.16	950	840
Fibreglas quilt	0.04	12	840
Timber flooring	0.14	650	1200
Concrete block	0.51	1400	1000
Foam insulation	0.04	10	1400
Concrete (slab)	1.13	1400	1000
Roofdeck	0.14	530	900

Table D : materials summary

III - 5 - Surfaces

III - 5 - 1 - Walls

The next table summarises the elements of surfaces, from inside to outside (see BESTEST Report, Table 1-15 to 1-18) :

Cases	Surface	Material	Thickness (mm)	U (W/m ² .K)		R (m ² .K/W)	
				Air-air	Surf-surf	Air-air	Surf-surf
lightweight	Wall	Plasterboard	12	0.514	0.559	1.944	1.789
		Fibreglass quilt	66				
		Wood siding	9				
	Roof	Plasterboard	10	0.318	0.334	3.147	2.992
		Fibreglass quilt	111.8				
		Roof deck	19				
	Floor	Timber flooring	25	0.039	0.040	25.374	25.254
Insulation ⁽¹⁾		1.003					
heavyweight	Wall	Concrete block	100	0.512	0.556	1.952	1.797
		Foam insulation	61.5				
		Wood siding	9				
	Roof	Identical to lightweight case					
	Floor	Concrete slab	80	0.039	0.040	25.366	25.246
Insulation		1.007					

Table E : walls summary

⁽¹⁾ The large insulating layer is not used in CoDyBa simulations : this layer is replaced with an adiabatic boundary condition.

III - 5 - 2 - Window

III - 5 - 2 - 1 - BESTEST Data

Number of panes	2
Pane thickness	3.175 mm
Air-gap thickness	13 mm
Normal direct-beam transmittance through one pane in air	0.862
Thermal conductivity of glass	1.06 W/m ² .K
Combined radiative and convective coefficient of air gap	6.297 W/m ² .K
Exterior combined surface coefficient	21 W/m ² .K
Interior combined surface coefficient	8.29 W/m ² .K
U-Value from interior air to ambient air	3 W/m ² .K
Hemispherical infrared emittance of ordinary uncoated glass	0.84 (or 0.9)
Density of glass	2500 kg/m ³
Specific heat of glass	750 J/kg.K
Double-pane shading coefficient at normal incidence	0.907
Double-pane solar heat gain coefficient at normal incidence	0.789

Table F : window summary

The height of the wall below the window is 0.2 m, 0.5 for the wall above the window.

Window overhang : the horizontal overhang for the south facing window is assumed to travel the entire length of the south wall. All other dimensions for shading devices are shown in the drawings (see figures A, B and C).

III - 5 - 2 - 2 - CoDyBa Data

The value of absorption coefficient at normal incidence (α (angle=0)) is taken at 0.0602.

Angular dependence of direct-beam transmittance for double-pane window is given in next table :

Angle	Base data of glass		Data calculated from base data for a glazing (2 glasses)			CoDyBa Test Transmission function		CoDyBa standard
	Absorption α	Transmission τ	Transmission τ_{Global}	Absorption outer glass	Absorption inner glass	Transmission function f_t	Absorption function f_a	Transmission function f_s
0	0,060234	0,861931	0,747454	0,0643	0,052234	1,00000	1,00000	1,00000
10	0,061007	0,861598	0,746824	0,0651	0,052881	0,99961	1,01283	0,99961
20	0,061734	0,860307	0,744654	0,0659	0,053435	0,99812	1,02490	0,99812
30	0,063570	0,857484	0,739891	0,0679	0,054852	0,99484	1,05537	0,99484
40	0,066125	0,851391	0,729832	0,0708	0,056683	0,98777	1,09779	0,98777
45	0,067690	0,845895	0,720922	0,07267	0,057689	0,98140	1,12377	0,98140
50	0,069179	0,837348	0,707331	0,074686	0,058474	0,97148	1,14850	0,97148
60	0,072157	0,801163	0,652331	0,0796	0,058753	0,92950	1,19794	0,92950
70	0,073522	0,700213	0,516754	0,0858	0,054260	0,81238	1,22060	0,81238
80	0,073615	0,451261	0,263009	0,094	0,042905	0,52355	1,22214	0,52355
85	0,067654	0,272477	0,131504	0,0892	0,032652	0,31612	1,12318	0,31612
89	0,035918	0,073882	0,026301	0,0473	0,012786	0,08572	0,59630	0,08572

Table G : glass data summary

Coefficients of two glasses glazing data are calculated by using the following formulas :

$$\alpha_{\text{outer glass}} = \alpha \left(1 + \frac{\tau \cdot \rho}{1 - \rho^2} \right), \tau_{\text{Global}} = \frac{\tau^2}{1 - \rho^2}, \text{ with } \rho = 1 - \alpha - \tau \text{ and } f_t(\theta) = \frac{\tau(\theta)}{\tau(0)}, f_a(\theta) = \frac{\alpha(\theta)}{\alpha(0)}$$

To get CoDyBa results to compare with BESTEST results, the "base data of glass" is used. But in the standard version of CoDyBa (commercial version), the usual CoDyBa transmission function f is used instead :

$$f = \begin{cases} 1 & \text{if } \cos(\text{incidence}) \geq C_0 \\ \cos(\text{incidence}) * \left(\frac{2}{C_0} - \frac{1}{C_0^2} \cdot \cos(\text{incidence}) \right) & \text{if } \cos(\text{incidence}) < C_0 \end{cases} \quad C_0 = 0.69$$

The results obtained with the CoDyBA function are slightly different, but they passed the BESTEST qualifications test cases (see chapter V-1-3).

For diffuse flux, the parameters are calculated with an integration over the viewed sky.

Interior solar distribution : CoDyBa calculates solar distribution of the incoming radiation. It supposes that radiation strike the floor first, and that all reflections are diffuse. The method used by CoDyBa is the method described in appendix F of BESTEST Report, with the restriction that the shape factor of a surface is calculated by the ratio of its surface to the sum of all the others.

III - 5 - 2 - 3 - Opaque window

For this case, the short wave radiation absorption coefficient is taken to 0. The absorption coefficient is that of the opaque walls. Other window properties remain the same (convective surface coefficients, materials, etc.).

Cases 200 to 250 include an opaque glazing with the following characteristics :

- No solar transmission.
- An external convection coefficient and thermophysical parameters identical to those of a standard glazing.
- Same emissivity and absorptance as for a wall.

III - 5 - 3 - Convective surface coefficients

BESTEST data are given in tables 1-5 and 1-6. The convective surface coefficients used in CoDyBa are obtained from values given in BESTEST Report by correcting with the emissivity ϵ and the value of the radiative portion of the combined coefficients ($5 \text{ W/m}^2\cdot\text{°C}$ as CoDyBa data). Note that the value taken in BESTEST Report is $5.7 \text{ W/m}^2\cdot\text{°C}$, the slight difference may explain some differences in the results.

The convective surface coefficients are detailed in table H (see BESTEST Report Table 1-5 and 1-6) :

Surface	Convective surface coefficients ($\text{W/m}^2\cdot\text{K}$)			
	Emissivity $\epsilon = 0.9$		Emissivity $\epsilon = 0.1$	
	Exterior	Interior	Exterior	Interior
Roof	24.8 (29.3 - 0.9*5)	1.63 (6.13 - 0.9*5)	24.7 (25.2 - 0.1*5)	1.07 (1.57 - 0.1*5)
Wall	27.05 (29.3 - 0.9*5/2)	3.79 (8.29 - 0.9*5)	24.95 (25.2 - 0.1*5/2)	3.23 (3.73 - 0.1*5)
Floor	29.3 (29.3 - 0)	4.76 (9.26 - 0.9*5)	25.2 (25.2 - 0)	4.2 (4.70 - 0.1*5)
Window	18.75 (21 - 0.9*5/2)	3.8	16.6 (16.9 - 0.9*5/2)	3.2

Table H : detailed convective surface coefficients summary

The glass exterior and interior convective surface coefficients are supposed as the same as opaque walls.

Since CoDyBa does not allow scheduling of horizontal convective surface coefficients, the interior coefficients for horizontal surfaces are taken as $8.29 \text{ W/m}^2\cdot\text{K}$ for the roof and the floor (see BESTEST Report, chapter 1.4.6). Then all interior convective surface coefficients have the same value.

In brief, the convective surface coefficients used in CoDyBa simulations are :

Surface	Convective surface coefficients ($\text{W/m}^2\cdot\text{K}$)			
	Emissivity $\epsilon = 0.9$		Emissivity $\epsilon = 0.1$	
	Exterior	Interior	Exterior	Interior
Roof	24.8	3.8	24.7	3.2
Wall	27	3.8	25	3.2
Floor	29.3	3.8	25.2	3.2

Table I : convective surface coefficients summary

III - 6 - Infiltration and internal load

III - 6 - 1 - Infiltration

For CoDyBa simulations the retained value of air change is 0.5 ACH, with an air density the value of is 0.9873 kg/m^3 (see BESTEST Report appendix B) :

III - 6 - 2 - Internally generated heat

The internally generated sources of heat from equipment, lights, people are not related to heating, ventilating or air conditioning (HVAC). The cases with internal sensible load are specified in paragraph 1.4.4. of BESTEST Report.

BESTEST data : the power of internal load assume a constant value of 200 W (60 % radiative, 40 % convective, 100 % sensible, 0 % latent).

CoDyBa data : in order to complete the missing values, repartition of 50%/50 % for short and long wave radiation is chosen (30 % short wave radiation, 30 % long wave radiation, 40 % convective, 100 % sensible, 0 % latent).

III - 6 - 3 - Mechanical system

III - 6 - 3 - 1 - Description

The following conditions are assumed : 100% convective air system, no latent loads, the thermostat is sensing only for the air temperature and is not proportional.

III - 6 - 3 - 2 - Thermostat control strategies

The thermostat control strategies are defined below :

20,20,-- or BANG-BANG

Action	Period	Set Point	Activity
Heating	all hours	T < 20 °C	on
Cooling		T > 20 °C	on

20,27,-- or DEADBAND

Action	Period	Set Point	Activity
Heating	all hours	T < 20 °C	on
Cooling		T > 27 °C	on

20,27,-- or SETBACK

Action	Period	Set Point	Activity
Heating	from 23 hours to 7 hours	T < 10 °C	on
	from 7 hours to 23 hours	T < 20 °C	on
Cooling	all hours	T > 27 °C	on

20,27,V or VENTING

Action	Period	Set Point	Activity
Heating	all hours	--	off
Cooling	from 18 hours to 7 hours	--	off
	from 7 hours to 18 hours	T > 27 °C	on
Venting	from 18 hours to 7 hours	--	on
	from 7 hours to 18 hours	--	off

Table J : control strategy summary

Note that for CoDyBa the thermostat control is based on the temperature of the central zone air node.

III - 6 - 3 - 3 - Equipment characteristics

The power of each equipment is assumed huge (10 kW), with an effective efficiency of 100%.

The vent fan capacity is 1703.16 m³/h (in addition to specified infiltration rate). As CoDyBa does not automatically correct the density of air, the fan capacity is adjusted to 13.14 ACH (Air Change per Hour, see BESTEST Report Table 1.10).

The nominal vent fan capacity is 1703.16 m³/h (in addition to specified infiltration rate). In CoDyBa data a value of 0.98 for the air density is taken, in order to take into account of the altitude. And the fan capacity is adjusted to 13.14 ACH (Air Change per Hour, see BESTEST Report Table 1.10).

IV - Tests description

IV - 1 - General cases description

There are 36 cases in all (plus 4 free-floating variants).

Qualification cases 600 to 650 and 900 to 990 represent a set of lightweight and heavyweight buildings that are relatively realistic. These cases test a program's ability to model such features as windows at different orientations, horizontal and vertical external shading devices, set-back thermostats, night ventilation, a passive solar sun-space, and ground coupling.

The case 600 is the start of the low-mass qualification series.

Diagnostic cases 195 to 320 represent an attempt to isolate the effects of individual algorithms by varying a single parameter from case to case. Results can be compared to a sensitivity analysis and enable one to study separately the physical phenomena such a conduction and convection.

Diagnostic cases 395 to 440 attempt to solve more realistic problems, but they do not provide as precise a diagnosis because of interactive effects.

IV - 2 - Qualification cases description

Case 600 : see geometrical data in figure A.

Case 610 is identical to case 600, except the adding of a 1 m horizontal overhang.

Case 620 use the geometry of case 600 with two windows facing east and west sides (6 m² area) instead of an unique window on south wall. The south window is replaced with a wall.

Case 630 : geometry of is the same as case 620, but an horizontal overhang and vertical fins are placed around the windows.

Case 640 : its geometry is the same as case 600, with the adding of a heating and cooling temperature setback schedule.

Case 650 : a ventilation is added to the data of case 600 (in addition to infiltration).

Series 900 : the 900 series of tests use the same building model as was used for the series 600 tests, except that wall and floor construction were changed to use heavier materials. Everything else remained the same.

Case 960 : the sun-space consists of two zones (back zone and sun zone) separated by a common wall. The back zone is of lightweight construction, and the sun zone is of heavyweight construction. This case need to give the distribution of the sun spot onto the various internal surfaces of the sun zone. It would be possible to use the distribution values given in BESTEST Report, but this procedure is not very complete, and would need some modifications in CoDyBa. For these reasons, the case 960 is not treated with CoDyBa.

Case 990 : the case 990 is the same as case 900, except that the building has sunk 1.35 m into the ground.

Cases **960** and **990** are in not treated in CoDyBa qualification tests.

IV - 3 - Test cases summary

Case	Setpoints H,C,V	Mass	Internal load ⁽¹⁾	ACH	Emissivity ⁽²⁾		Absorption ⁽³⁾		Glass		Shade
					Internal	External	Internal SWR	External SWR	Area (m ²)	Orientation	
195	20,20,--	LW	No	0	0.1	0.1	NA	0.1	0	S	No
200	20,20,--	LW	No	0	0.1	0.1	NA	0.1	0	S	No
210	20,20,--	LW	No	0	0.1	0.9	NA	0.1	0	S	No
215	20,20,--	LW	No	0	0.9	0.1	NA	0.1	0	S	No
220	20,20,--	LW	No	0	0.9	0.9	NA	0.1	0	S	No
230	20,20,--	LW	No	1	0.9	0.9	NA	0.1	0	S	No
240	20,20,--	LW	Yes	0	0.9	0.9	NA	0.1	0	S	No
250	20,20,--	LW	No	0	0.9	0.9	NA	0.9	0	S	No
270	20,20,--	LW	No	0	0.9	0.9	0.9	0.1	12	S	No
280	20,20,--	LW	No	0	0.9	0.9	0.1	0.1	12	S	No
290	20,20,--	LW	No	0	0.9	0.9	0.9	0.1	12	S	1m H
300	20,20,--	LW	No	0	0.9	0.9	0.9	0.1	6,6	E,W	No
310	20,20,--	LW	No	0	0.9	0.9	0.9	0.1	6,6	E,W	1mHV
320	20,27,--	LW	No	0	0.9	0.9	0.9	0.1	12	S	No
395	20,27,--	LW	No	0	0.9	0.9	NA	0.1	⁽³⁾	S	No
400	20,27,--	LW	No	0	0.9	0.9	NA	0.1	0	S	No
410	20,27,--	LW	No	0.5	0.9	0.9	NA	0.1	0	S	No
420	20,27,--	LW	Yes	0.5	0.9	0.9	NA	0.1	0	S	No
430	20,27,--	LW	Yes	0.5	0.9	0.9	NA	0.6	0	S	No
440	20,27,--	LW	Yes	0.5	0.9	0.9	0.1	0.6	12	S	No
600	20,27,--	LW	Yes	0.5	0.9	0.9	0.6	0.6	12	S	No
610	20,27,--	LW	Yes	0.5	0.9	0.9	0.6	0.6	12	S	1m H
620	20,27,--	LW	Yes	0.5	0.9	0.9	0.6	0.6	6,6	E,W	No
630	20,27,--	LW	Yes	0.5	0.9	0.9	0.6	0.6	6,6	E,W	1mHV
640	SETBACK	LW	Yes	0.5	0.9	0.9	0.6	0.6	12	S	No
650	--,27,V	LW	Yes	0.5	0.9	0.9	0.6	0.6	12	S	No
800	20,27,--	HW	Yes	0.5	0.9	0.9	NA	0.6	0	S	No
810	20,27,--	HW	Yes	0.5	0.9	0.9	0.1	0.6	12	S	No
900	20,27,--	HW	Yes	0.5	0.9	0.9	0.6	0.6	12	S	No
910	20,27,--	HW	Yes	0.5	0.9	0.9	0.6	0.6	12	S	1m H
920	20,27,--	HW	Yes	0.5	0.9	0.9	0.6	0.6	6,6	E,W	No
930	20,27,--	HW	Yes	0.5	0.9	0.9	0.6	0.6	6,6	E,W	1mHV
940	SETBACK	HW	Yes	0.5	0.9	0.9	0.6	0.6	12	S	No
950	--,27,V	HW	Yes	0.5	0.9	0.9	0.6	0.6	12	S	No
600FF	NONE	The cases labelled FF (Free-Float) are exactly the same as the non FF cases, except there are no heating or cooling systems. Thus the interior temperatures are allowed to be free-float.									
900FF	NONE										
650FF	NONE,V										
950FF	NONE,V										

Table K : BESTEST cases summary

Titles	H	Heating	SWR	Short Wave Radiation
	C	Cooling	Shade	window shading device
	V	Venting	E, W, S	East, West, South
	LW	Lightweight	1 m H	1 meter deep horizontal shade
	HW	Heavyweight	HV	Combination and Horizontal shade
	ACH	Air Change per Hour		

⁽¹⁾ Internal Load : the constant heat input is 200 W if "Yes", else 0.

⁽²⁾ Emissivity

⁽³⁾ Absorption : coefficient of short wave radiation absorption.

⁽⁴⁾ Case 395 has neither a window, nor an "opaque window". It consists of 100% normally insulated wall as specified for the lightweight case.

Note : interior short wave absorptance does not matter when glass area is 0.

V - Results

This section presents the results from CoDyBa compared to the results of BESTEST reference applications. The final results from CoDyBa program are presented here in tabular and graphic form.

CoDyBa result values which exceed the BESTEST bounds are **indicated in bold** in the tables.

The next table (Table L, chapter V-1) shows the results in tabular format and also includes a row for each comparison indicating the number of times where the CoDyBa values are without the range.

Note that BESTEST does not retain all results of reference applications, because some results are considered as "bad" in a few cases.

A series of "Delta Results" were also generated (presented in Table N, chapter V-1-2) which compare the difference in results between certain cases in order to isolate the sensitivity of each program to changes in building features such as mass construction, addition of windows with and without shading, thermostat setback, ventilation cooling, etc.

Results obtained with the CoDyBa commercial version are presented in Table M, chapter V-1-3). The data differences are the specific glass laws.

One measure of comparison as to how well CoDyBa predicted thermal loads compared to the other programs is to see if the results fall within the range of spread of results for other programs. This can be visually with the charts presented in next chapters. The comparison charts contain three bars :

- Max BESTEST (the highest result among the reference applications)
- CDB (results from CoDyBa)
- Min BESTEST (the lowest result among the reference applications)

V - 1 - CoDyBa Results in tabular form

V - 1 - 1 - BESTEST and CoDyBa Results in tabular form

case	CoDyBa Results						BESTEST Reference Results										in/ out
	HE	CE	HP	CP	MinT	MaxT	MinHE	MaxHE	MinCE	MaxCE	MinHP	MaxHP	MinCP	MaxCP	MinT	MaxT	
195	4,77	0,497	2,17	0,809			4,167	5,871	0,264	0,51	2,004	2,385	0,616	0,853			0
200	6,455	0,702	2,975	1,122			5,252	6,882	0,57	0,716	2,651	3,382	0,863	1,126			0
210	6,604	0,675	3,017	1,104			6,456	6,967	0,162	0,681	2,701	3,325	0,476	1,142			0
215	7,347	0,802	3,394	1,279			5,547	7,943	0,639	0,853	2,787	3,65	1,007	1,347			0
220	7,577	0,775	3,466	1,267			6,944	8,127	0,186	0,835	2,867	3,709	0,56	1,342			0
230	11,113	1,075	5,051	1,804			10,376	11,649	0,454	1,139	4,386	5,293	1,059	1,878			0
240	6,373	1,147	3,286	1,447			5,649	6,786	0,415	1,246	2,685	3,509	0,739	1,542			0
250	6,183	2,466	3,466	2,324			4,751	6,653	2,177	3,38	2,866	3,709	2,258	3,36			0
270	5,207	8,865	3,459	6,737			4,51	5,489	7,528	9,631	2,863	3,738	6,356	7,163			0
280	5,562	5,528	3,463	4,564			4,675	5,937	4,873	6,511	2,864	3,759	4,444	5,759			0
290	5,321	6,285	3,46	6,491			4,577	5,539	5,204	7,721	2,863	3,738	6,203	6,91			0
300	5,395	5,926	3,463	4,744			4,761	5,964	4,302	6,525	3,014	3,77	3,404	4,929			0
310	6,024	3,522	3,464	3,947			5,221	6,165	2,732	5,471	3,015	3,771	2,848	4,666			0
320	4,462	5,956	3,455	6,068			3,859	5,141	5,061	6,576	2,861	3,735	5,701	6,484			0
395	4,861	0,014	2,256	0,402			4,8	5,84	0	0,02	2,062	2,39	0	0,421			0
400	7,432	0,049	3,466	0,645			6,9	8,77	0	0,061	2,867	3,709	0	0,712			0
410	9,196	0,07	4,259	0,786			8,596	9,734	0	0,084	3,625	4,501	0,035	0,863			0
420	7,974	0,162	4,079	1,004			7,298	8,373	0,011	0,189	3,443	4,301	0,258	1,078			0
430	6,929	0,551	4,084	1,638			5,429	7,827	0,422	0,875	3,442	4,301	1,427	1,798			0
440	5,448	3,572	4,095	4,325			4,449	5,811	3,967	5,204	3,439	4,376	4,424	5,615			2
600	5,063	6,326	4,074	6,258			4,296	5,709	6,137	7,964	3,437	4,354	4,965	6,812			0
610	5,177	4,026	4,075	5,877			4,355	5,786	3,915	5,778	3,437	4,354	5,699	6,146			0
620	5,378	3,953	4,079	4,647			4,613	5,944	3,417	5,004	3,591	4,379	3,634	5,096			0
630	6,078	2,171	4,081	3,887			5,05	6,469	2,129	3,701	3,592	4,278	3,072	3,704			1
640	3,212	6,05	6,614	6,215			2,751	3,803	5,952	7,811	5,232	6,954	5,892	7,537			0
650	0	4,821	0	6,113			0	0	4,816	6,545	0	0	5,831	6,679			0
800	6,437	0,185	3,963	1,115			4,868	6,611	0,055	0,325	3,227	4,188	0,585	1,382			0
810	3,099	1,084	3,814	2,407			1,839	3,004	1,052	1,711	2,979	4,115	1,852	2,991			1
900	1,853	2,381	3,699	3,439			1,17	2,041	2,132	3,415	2,85	3,797	2,888	3,567			0
910	2,411	0,979	3,705	2,444			1,575	2,282	0,821	1,872	2,858	3,801	1,896	3,147			1
920	4,088	2,432	3,869	3,354			3,313	4,3	1,84	3,092	3,308	4,061	2,385	3,505			0
930	5,281	1,242	3,917	2,597			4,143	5,335	1,039	2,238	3,355	4,064	1,873	2,546			1
940	1,339	2,311	6,853	3,439			0,793	1,411	2,079	3,241	3,98	6,428	2,888	3,871			1
950	0	0,427	0	2,737			0	0,001	0,387	0,921	0	0	2,033	2,867			0
600FF					-18,10	63,28											
650FF					-22,82	61,38											
900FF					-4,24	42,15											
950FF					-19,85	34,94											

Table L : detailed CoDyBa results (BESTEST glass data)

- | | | | |
|---------------|---|----------------|------------------------|
| HE : | Heating Energy | MinHE : | minimum Heating Energy |
| CE : | Cooling Energy | MinCE : | minimum Cooling Energy |
| HP : | Heating Peak | MinHP : | minimum Heating Peak |
| CP : | Cooling Peak | MinCP : | minimum Cooling Peak |
| in/out | number of results values out of BESTEST range | | |

V - 1 - 2 - BESTEST and CoDyBa Delta Results

case	CoDyBa Results				BESTEST Reference Results								in/ out
	HE	CE	HP	CP	MinHE	MaxHE	MinCE	MaxCE	MinHP	MaxHP	MinCP	MaxCP	
610-600	0,114	-2,299	0	-0,38	0,021	0,098	-2,227	-1,272	-0,011	0	-0,811	-0,116	2
620-600	0,314	-2,372	0,004	-1,61	0,138	0,682	-2,96	-2,341	-0,008	0,24	-2,56	-1,716	1
630-620	0,699	-1,782	0,001	-0,759	0,267	0,551	-1,845	-0,984	-0,021	0,003	-0,842	-0,371	1
640-600	-1,851	-0,275	2,539	-0,043	-2,166	-1,545	-0,32	-0,153	1,546	2,6	-0,08	-0,014	0
650-600	-5,063	-1,505	-4,074	-0,145	---	---	-1,419	-1,284	---	---	-0,163	-0,108	1
900-600	-3,21	-3,944	-0,374	-2,818	-3,837	3,126	-4,624	-3,833	-0,587	-0,414	-3,355	-2,81	1
910-900	0,558	-1,401	0,005	-0,995	0,179	0,442	-1,561	-0,832	0,003	0,019	-1,122	-0,31	1
920-900	2,235	0,05	0,169	-0,085	2,07	2,505	-0,323	0,016	0,192	0,458	-0,517	0,048	2
930-920	1,192	-1,189	0,048	-0,756	0,595	1,08	-1,174	-0,682	0,027	0,127	-0,721	-0,387	3
940-900	-0,514	-0,07	3,153	0	-0,718	-0,377	-0,174	-0,053	1,13	2,631	0	0	1
950-900	-1,853	-1,954	-3,699	-0,702	---	---	-2,826	-1,745	---	---	-0,881	-0,534	0
800-430	-0,491	-0,365	-0,12	-0,522	-0,649	0,501	-0,55	-0,367	-0,215	-0,113	-1,22	-0,397	1
900-800	-4,584	2,195	-0,263	2,324	-5,356	-3,698	2,019	3,193	-0,378	-0,107	2,099	3,519	0
900-810	-1,246	1,297	-0,114	1,032	-1,107	-0,669	0,975	1,707	-0,166	-0,034	0,595	3,458	1
910-610	-2,765	-3,046	-0,37	-3,432	-3,532	-2,78	-3,924	3,094	-0,579	-0,223	-3,773	-2,883	1
920-620	-1,29	-1,521	-0,21	-1,292	-1,689	-1,297	-1,912	-1,476	-0,318	-0,15	-1,591	-1,106	1
930-630	-0,797	-0,928	-0,163	-1,289	-1,273	-0,712	-1,463	-0,827	-0,238	-0,141	-1,242	-1,036	1
940-640	-1,873	-3,739	0,239	-2,775	-2,392	-1,867	-4,57	-3,647	-1,252	1,845	-3,314	-2,636	0
950-650	0	-4,393	0	-3,375	0	0	-5,956	-4,429	0	0	-3,998	-3,21	1
400-395	2,571	0,034	1,209	0,243	1,916	2,935	0	0,045	0,805	1,318	0	0,291	0
410-400	1,763	0,021	0,792	0,141	1,696	1,798	0	0,026	0,757	0,885	0,035	0,151	0
420-410	-1,222	0,091	-0,179	0,217	-1,361	-1,222	0,011	0,105	-0,2	-0,18	0,195	0,233	0
430-420	-1,045	0,389	0,004	0,634	-1,869	-1,112	0,371	0,732	-0,001	0,011	0,637	1,657	2
600-430	-1,865	5,774	-0,009	4,62	-2,118	-1,133	5,595	7,28	-0,029	0,217	4,193	5,772	0
440-600	0,385	-2,753	0,02	-1,932	0,153	0,426	-2,76	-2,094	-0,001	0,022	-1,936	-1,534	0
200-195	1,684	0,205	0,805	0,312	1,085	1,961	0,156	0,241	0,647	1,119	0,212	0,336	0
210-200	0,149	-0,027	0,041	-0,017	0	1,204	-0,408	0,008	-0,057	0,05	-0,387	0,016	0
220-215	0,229	-0,026	0,072	-0,011	0	1,397	-0,453	0,012	0	0,08	-0,447	0,021	0
215-200	0,892	0,099	0,418	0,157	0,295	1,26	0,038	0,154	0,076	0,603	0,066	0,236	0
220-210	0,972	0,099	0,449	0,162	0,47	1,333	0,024	0,154	0,166	0,632	0,071	0,241	0
230-220	3,535	0,3	1,585	0,536	3,432	3,615	0,268	0,304	1,519	1,811	0,48	0,536	0
240-220	-1,203	0,371	-0,179	0,179	-1,341	-1,203	0,229	0,412	-0,2	-0,18	0,179	0,2	0
250-220	-1,394	1,69	0	1,056	-2,193	-1,448	1,752	3,027	-0,007	0,005	1,043	3,699	2
270-220	-2,369	8,09	-0,006	5,469	-2,434	-1,948	7,342	9,515	-0,025	0,218	5,475	6,625	1
280-270	0,354	-3,336	0,003	-2,173	0,165	0,455	-3,236	-2,457	0	0,021	-2,208	-1,631	1
320-270	-0,745	-2,909	-0,004	-0,669	-0,779	-0,649	-3,055	-2,467	-0,009	0	-0,726	-0,586	0
290-270	0,114	-2,58	0	-0,246	0,02	0,088	-2,324	-1,283	-0,008	0	-0,561	-0,086	2
300-270	0,187	-2,939	0,003	-1,992	0,044	0,59	-3,25	-2,834	-0,008	0,259	-2,952	-1,938	0
310-300	0,629	-2,403	0,001	-0,797	0,201	1,349	-3,31	-1,266	-0,013	0,001	-1,504	-0,344	0

Table M : detailed CoDyBa delta results (BESTEST glass data)

HE : Heating Energy

CE : Cooling Energy

HP : Heating Peak

CP : Cooling Peak

in/out number of results values out of BESTEST range

MinHE : minimum Heating Energy

MinCE : minimum Cooling Energy

MinHP : minimum Heating Peak

MinCP : minimum Cooling Peak

V - 1 - 3 - BESTEST and CoDyBa Results (Standard/Commercial Version)

case	CoDyBa Results						BESTEST Reference Results										in/ out
	HE	CE	HP	CP	MinT	MaxT	MinHE	MaxHE	MinCE	MaxCE	MinHP	MaxHP	MinCP	MaxCP	MinT	MaxT	
195	4,77	0,497	2,17	0,809			4,167	5,871	0,264	0,51	2,004	2,385	0,616	0,853			0
200	6,455	0,702	2,975	1,122			5,252	6,882	0,57	0,716	2,651	3,382	0,863	1,126			0
210	6,604	0,675	3,017	1,104			6,456	6,967	0,162	0,681	2,701	3,325	0,476	1,142			0
215	7,347	0,802	3,394	1,279			5,547	7,943	0,639	0,853	2,787	3,65	1,007	1,347			0
220	7,577	0,775	3,466	1,267			6,944	8,127	0,186	0,835	2,867	3,709	0,56	1,342			0
230	11,113	1,075	5,051	1,804			10,376	11,649	0,454	1,139	4,386	5,293	1,059	1,878			0
240	6,373	1,147	3,286	1,447			5,649	6,786	0,415	1,246	2,685	3,509	0,739	1,542			0
250	6,183	2,466	3,466	2,324			4,751	6,653	2,177	3,38	2,866	3,709	2,258	3,36			0
270	5,206	8,874	3,459	6,881			4,51	5,489	7,528	9,631	2,863	3,738	6,356	7,163			0
280	5,563	5,515	3,463	4,646			4,675	5,937	4,873	6,511	2,864	3,759	4,444	5,759			0
290	5,317	6,382	3,459	6,579			4,577	5,539	5,204	7,721	2,863	3,738	6,203	6,91			0
300	5,392	5,945	3,463	4,772			4,761	5,964	4,302	6,525	3,014	3,77	3,404	4,929			0
310	6,01	3,565	3,464	3,975			5,221	6,165	2,732	5,471	3,015	3,771	2,848	4,666			0
320	4,462	5,968	3,455	6,25			3,859	5,141	5,061	6,576	2,861	3,735	5,701	6,484			0
395	4,861	0,014	2,256	0,402			4,8	5,84	0	0,02	2,062	2,39	0	0,421			0
400	7,432	0,049	3,466	0,645			6,9	8,77	0	0,061	2,867	3,709	0	0,712			0
410	9,196	0,07	4,259	0,786			8,596	9,734	0	0,084	3,625	4,501	0,035	0,863			0
420	7,974	0,162	4,079	1,004			7,298	8,373	0,011	0,189	3,443	4,301	0,258	1,078			0
430	6,929	0,551	4,084	1,638			5,429	7,827	0,422	0,875	3,442	4,301	1,427	1,798			0
440	5,448	3,559	4,095	4,434			4,449	5,811	3,967	5,204	3,439	4,376	4,424	5,615			1
600	5,062	6,335	4,074	6,432			4,296	5,709	6,137	7,964	3,437	4,354	4,965	6,812			0
610	5,172	4,112	4,074	5,96			4,355	5,786	3,915	5,778	3,437	4,354	5,699	6,146			0
620	5,374	3,968	4,079	4,687			4,613	5,944	3,417	5,004	3,591	4,379	3,634	5,096			0
630	6,063	2,201	4,081	3,914			5,05	6,469	2,129	3,701	3,592	4,278	3,072	3,704			1
640	3,21	6,058	6,608	6,389			2,751	3,803	5,952	7,811	5,232	6,954	5,892	7,537			0
650	0	4,823	0	6,292			0	0	4,816	6,545	0	0	5,831	6,679			0
800	6,437	0,185	3,963	1,115			4,868	6,611	0,055	0,325	3,227	4,188	0,585	1,382			0
810	3,07	1,046	3,811	2,372			1,839	3,004	1,052	1,711	2,979	4,115	1,852	2,991			2
900	1,822	2,352	3,695	3,553			1,17	2,041	2,132	3,415	2,85	3,797	2,888	3,567			0
910	2,37	1,01	3,7	2,532			1,575	2,282	0,821	1,872	2,858	3,801	1,896	3,147			1
920	4,083	2,444	3,868	3,368			3,313	4,3	1,84	3,092	3,308	4,061	2,385	3,505			0
930	5,259	1,263	3,916	2,616			4,143	5,335	1,039	2,238	3,355	4,064	1,873	2,546			1
940	1,311	2,28	6,845	3,552			0,793	1,411	2,079	3,241	3,98	6,428	2,888	3,871			1
950	0	0,401	0	2,672			0	0,001	0,387	0,921	0	0	2,033	2,867			0
600FF					-18.05	64.36											
650FF					-22.82	62.22											
900FF					-4.12	41.83											
950FF					-19.83	34.75											

Table N : detailed CoDyBa results (CoDyBa commercial version glass data)

HE :	Heating Energy	MinHE :	minimum Heating Energy
CE :	Cooling Energy	MinCE :	minimum Cooling Energy
HP :	Heating Peak	MinHP :	minimum Heating Peak
CP :	Cooling Peak	MinCP :	minimum Cooling Peak
in/out	number of results values out of BESTEST range		

V - 2 - BESTEST Qualification Cases

V - 2 - 1 - BESTEST Qualification : Annual Incident Solar Radiation

	Annual Incident Solar Radiation (diffuse+direct, kWh/m ²)				
	North	East	West	South	Horizontal
Min BESTEST	367	959	1002	1456	1797
CDB	459	967	1093	1477	1832
Max BESTEST	456	1217	1090	1566	1832

Table O : Annual Incident Solar Radiation

Fig. R1 : Annual Incident Solar Radiation

There is no significant differences between CoDyBa and BESTEST results.

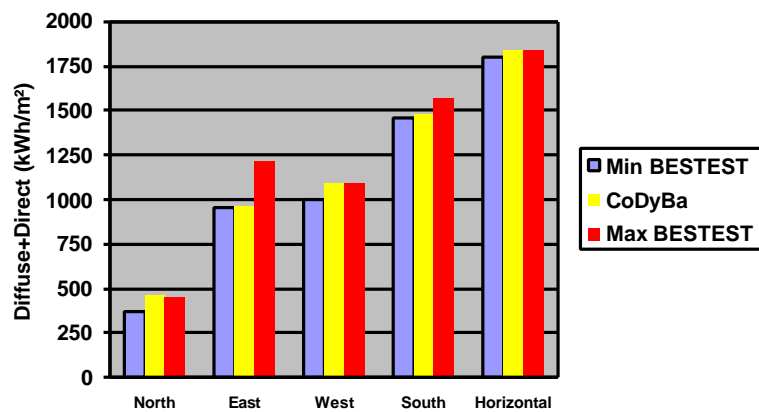

Values of incident solar radiation are obtained by integrating the diffuse and direct absorbed solar fluxes on the walls of the building, and by correcting by the absorption coefficient and the wall surface.

But as can be seen the sky model choice gives different results.

V - 2 - 2 - BESTEST Qualification : Annual Transmitted Solrad Unshaded

	Annual Transmitted Solrad Unshaded (diffuse+direct, kWh/m ²)	
	620 West	600 South
Min BESTEST	563	914
CDB	737	965
Max BESTEST	735	1051

Table P : Annual Transmitted Solrad Unshaded

Fig. R2 : Annual Transmitted Solrad Unshaded

One failure : for the west orientation, the annual transmitted solar flux predicted by CoDyBa is slightly over the BESTEST maximum.

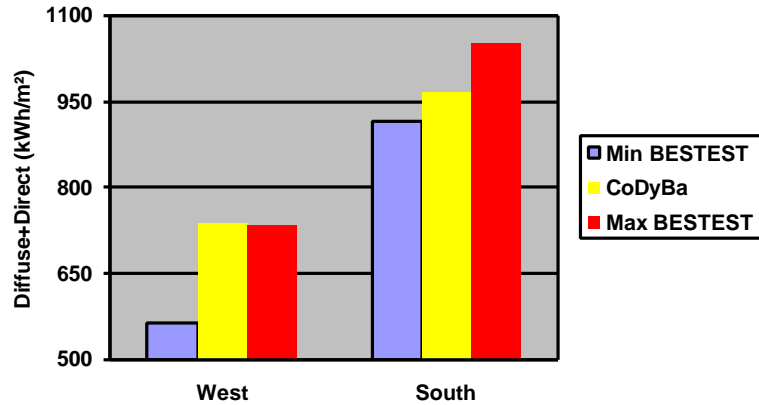

V - 2 - 3 - BESTEST Qualification : Annual Transmitted Solrad Shaded

	Annual Transmitted Solrad Unshaded (diffuse+direct, kWh/m ²)	
	930 West	910 South
Min BESTEST	431	757
CDB	455	735
Max BESTEST	599	831

Table Q : Annual Transmitted Solrad Shaded

Fig. R3 : Annual Transmitted Solrad Shaded

One failure : for the south orientation with an overhang, the annual transmitted solar flux predicted by CoDyBa is slightly under the BESTEST minimum.

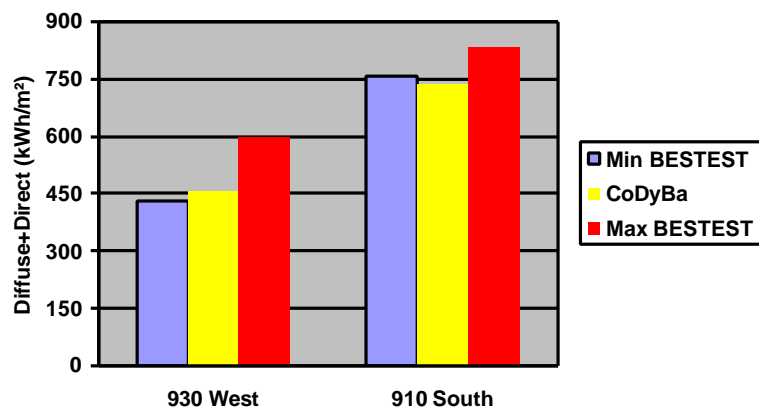

V - 2 - 4 - BESTEST Qualification : Annual Transmissivity Coefficient of Windows

This coefficient is calculated by the formula :

$$\frac{\text{(Annual Transmitted Solrad Unshaded)}}{\text{(Annual Incident Solrad Radiation)}}$$

	Annual Transmissivity Coefficient of Windows	
	930 West	910 South
Min BESTEST	0.641	0.623
CDB	0.674	0.653
Max BESTEST	0.687	0.671

Table R : Annual Transmissivity Coefficient of Windows

Fig. R4 : Annual Transmissivity Coefficient of Windows

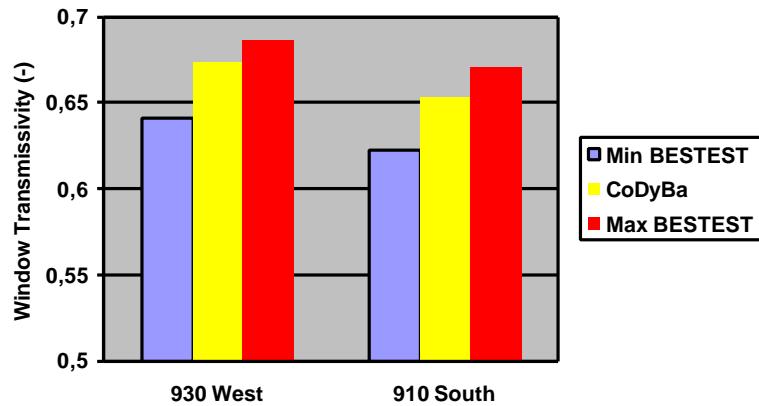

V - 2 - 5 - BESTEST Qualification : Annual Overhang and Fin Shading Coefficients

This coefficient is calculated by the formula :

$$\frac{\text{(Annual Transmitted Solrad Unshaded - Annual Transmitted Solrad Shaded)}}{\text{(Annual Incident Solar Radiation)}}$$

	Annual Overhang and Fin Shading Coefficients	
	930 West	910 South
Min BESTEST	0.182	0.165
CDB	0.258	0.156
Max BESTEST	0.346	0.209

Table S : Annual Overhang and Fin Shading Coefficients

Fig. R5 : Annual Overhang and Fin Shading Coefficients

One failure : for the south orientation with an overhang, the value predicted by CoDyBa is slightly under the BESTEST minimum.

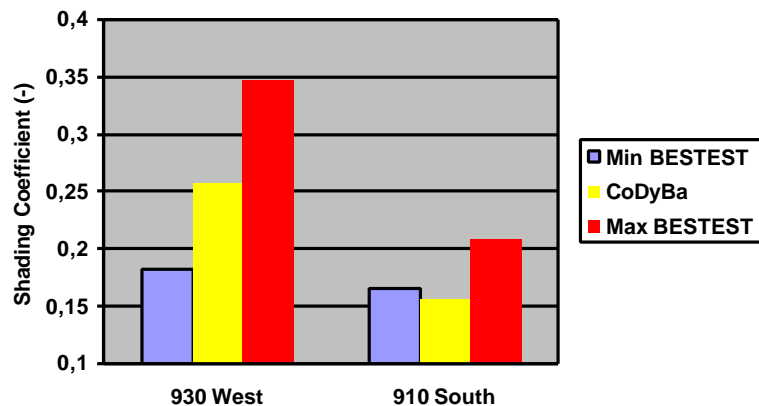

V - 2 - 6 - BESTEST Qualification : Low Mass Building

Fig. R6 : Low Mass Annual Heating

All CoDyBa results are within BESTEST range.

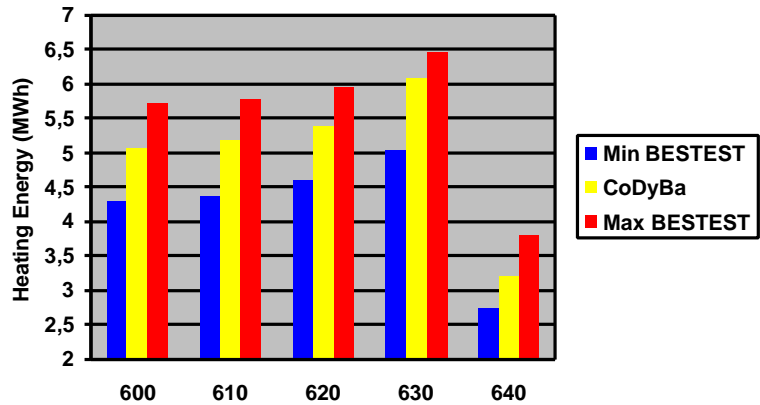

Fig. R7 : Low Mass Annual Cooling

All CoDyBa results are within BESTEST range.

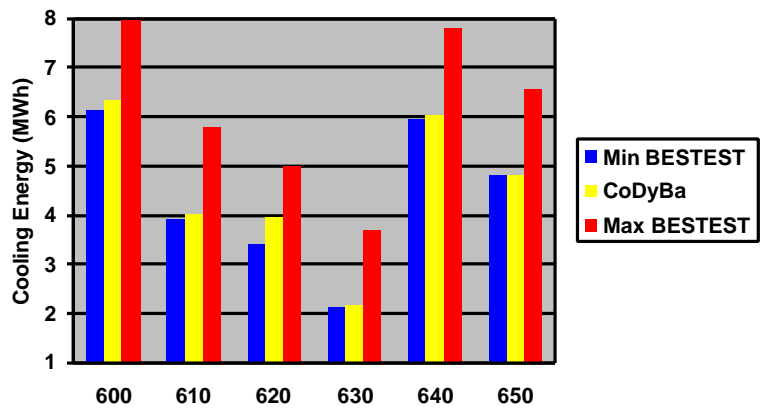

Fig. R8 : Low Mass Peak Heating

All CoDyBa results are within BESTEST range.

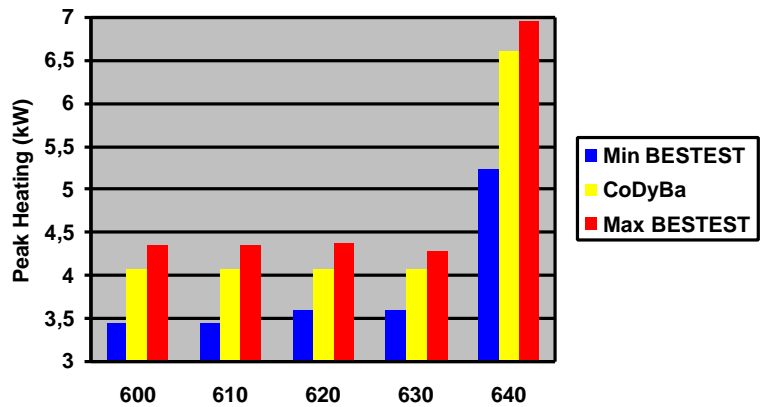
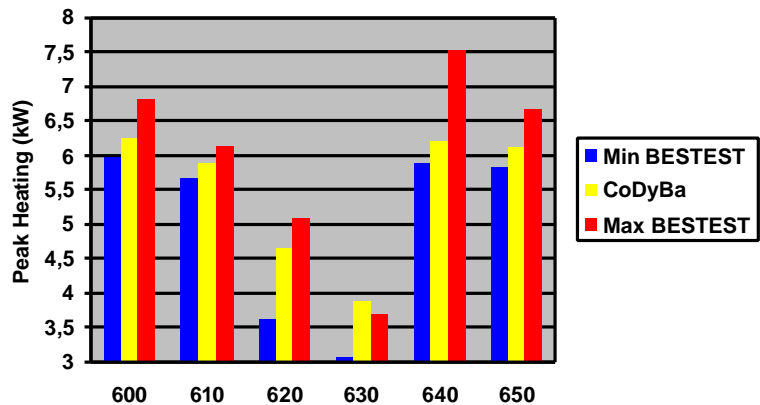

Fig. R9 : Low Mass Peak Cooling

One failure : for case 630, the peak cooling predicted by CoDyBa is slightly over the BESTEST maximum.



V - 2 - 7 - BESTEST Qualification : High Mass Building

Fig. R10 : High Mass Annual Heating

One failure : for case 910, the annual heating predicted by CoDyBa is slightly over the BESTEST maximum.

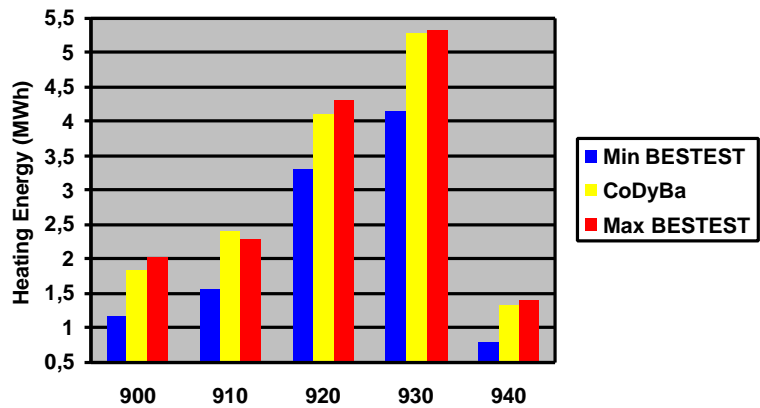

Fig. R11 : High Mass Annual Cooling

All CoDyBa results are within BESTEST range.

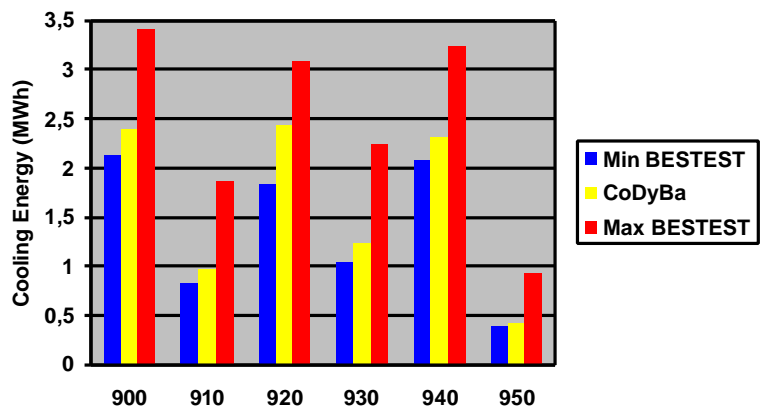

Fig. R12 : High Mass Peak Heating

One failure : for case 940, the peak heating predicted by CoDyBa is over the BESTEST maximum.

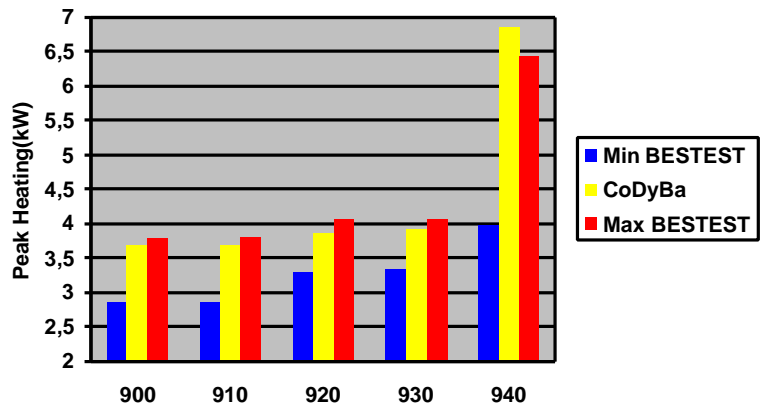
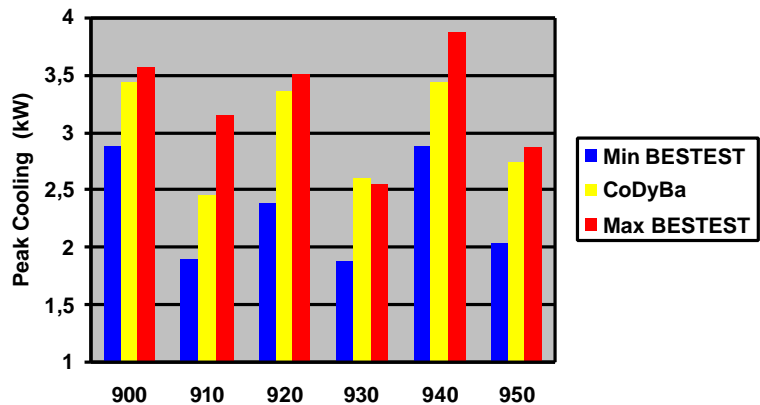

Fig. R13 : High Mass Peak Cooling

One failure : for case 930, the peak cooling predicted by CoDyBa is slightly over the BESTEST maximum.



V - 2 - 8 - BESTEST Qualification : Free-Float Cases

Case	600FF			650FF			900FF			950FF		
	Min	Max	CDB	Min	Max	CDB	Min	Max	CDB	Min	Max	CDB
Minimum hourly annual temperature	-18,8	-15,6	-18,10	-23,0	-21,6	-22,82	-6,4	-1,6	-4,24	-20,2	-18,6	-19,85
Maximum hourly annual temperature	64,9	69,8	63,28	63,2	68,5	61,38	41,8	44,8	42,15	35,5	38,5	34,94
Average hourly annual temperature	24,2	25,9	24,65	18,0	19,6	17,98	24,5	25,9	24,67	14,0	15,0	13,61

Table T : Free-Float Temperatures

Fig. R14 : Maximum Hourly Annual Temperature

Three failures : for cases 600FF, 650FF and 950FF, the maximum temperatures predicted by CoDyBa are slightly under the BESTEST minimum.

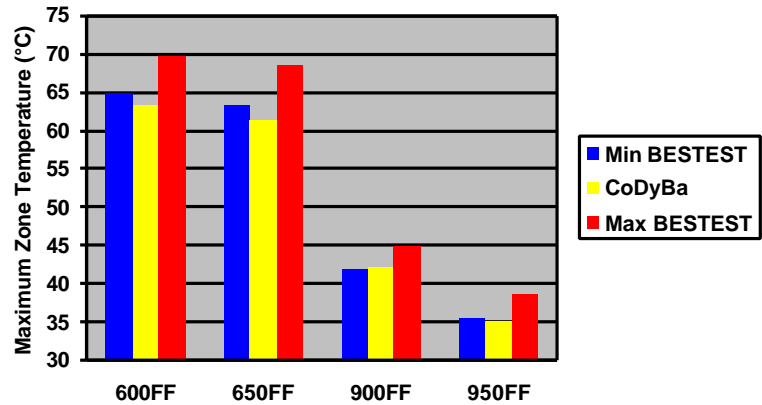

Fig. R15 : Minimum Hourly Annual Temperature

All CoDyBa results are within BESTEST range.

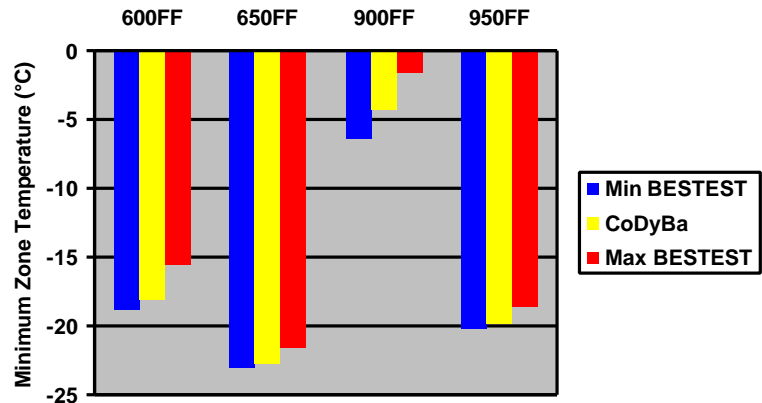
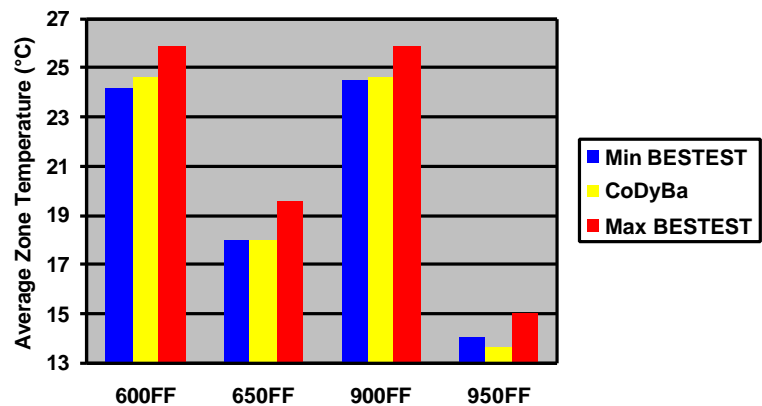

Fig. R16 : Average Hourly Annual Temperature

Four failures : for case 950FF, the average temperature predicted by CoDyBa are slightly under the BESTEST minimum.



V - 2 - 9 - BESTEST Qualification : Case 900FF

V - 2 - 9 - 1 - Case 900FF : hourly incident solar flux density

Hour	Cloudy day (5 th march)						Clear day (27 th july)					
	South surface			West surface			South surface			West surface		
	MinB	MaxB	CDB	MinB	MaxB	CDB	MinB	MaxB	CDB	MinB	MaxB	CDB
1	0	0	0	0	0	0	0	0	0	0	0	0
2	0	0	0	0	0	0	0	0	0	0	0	0
3	0	0	0	0	0	0	0	0	0	0	0	0
4	0	0	0	0	0	0	0	0	0	0	0	0
5	0	0	0	0	0	0	0	0,5	0	0	0,4	0
6	0	0	0	0	0	0	17,9	29,94	25,5	17,9	29,94	25,5
7	1,5	3,05	3,0	1,6	3	3,0	58,6	89,2	62,7	58,5	89,2	62,7
8	12,59	21	19,8	13,5	20,24	19,8	71,22	112,85	109,3	71,22	112,85	71,4
9	30,01	39	39,0	31	38,01	37,8	164,86	232,33	233,9	85,58	125	93,4
10	46,23	55	53,9	45,24	53,27	52,9	291,84	349,16	346,5	98,03	140	112,3
11	54,77	66,08	65,4	53,37	64,47	64,3	389,26	435,54	437,6	109,14	154	138,2
12	59,65	72	71,9	57,91	70	69,8	437,2	475,37	462,7	113,06	157	151,2
13	60,1	72,42	72,6	58,3	71,16	71,2	452,5	488,49	470,1	117,94	382,5	386,6
14	55,24	68,1	66,0	54,15	67,3	65,8	400,56	443,66	402,0	333,68	576,81	574,2
15	45,68	58,9	54,7	45,38	58,9	55,0	316,94	367,07	321,9	525,35	744,52	747,2
16	32,37	44,4	39,3	32,7	44,9	40,7	188,89	246,71	196,4	634,59	807,29	804,1
17	17,06	26,9	19,8	16,72	27,6	19,9	86,03	132,3	133,4	478,44	649,05	544,5
18	0	8,7	3,0	0	9	3,0	68,47	78,8	76,6	139	296,9	146,7
19	0	0	0	0	0	0	14,35	37,1	18,2	21,96	68,8	20,3
20	0	0	0	0	0	0	0	1,1	0,1	0	1,6	0,1
21	0	0	0	0	0	0	0	0	0	0	0	0
22	0	0	0	0	0	0	0	0	0	0	0	0
23	0	0	0	0	0	0	0	0	0	0	0	0
24	0	0	0	0	0	0	0	0	0	0	0	0

Table U : hourly incident solar flux density

Fig. R17 : incident solar flux density, cloudy day, south surface

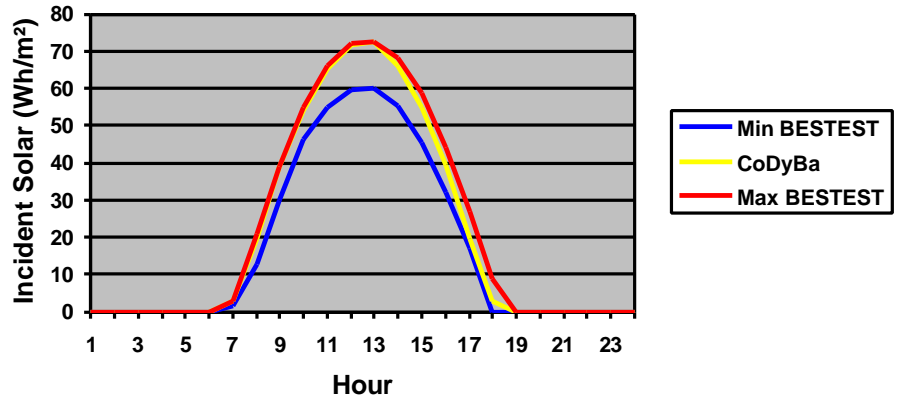

Fig. R18 : incident solar flux density, cloudy day, west surface

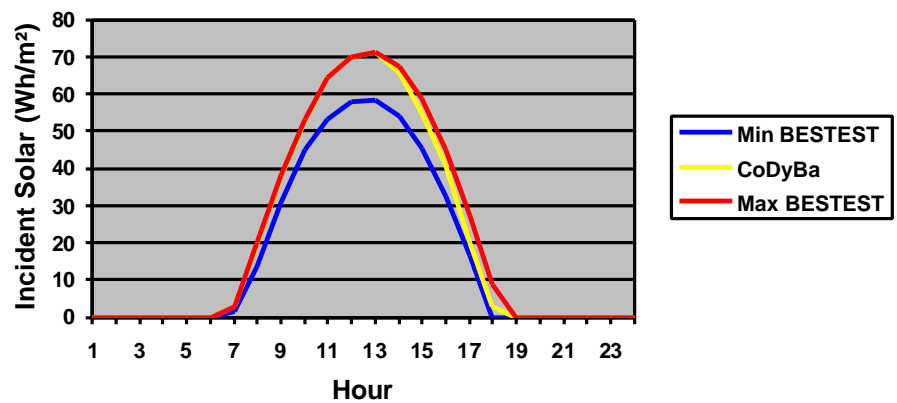

Fig. R19 : incident solar flux density, clear day, south surface

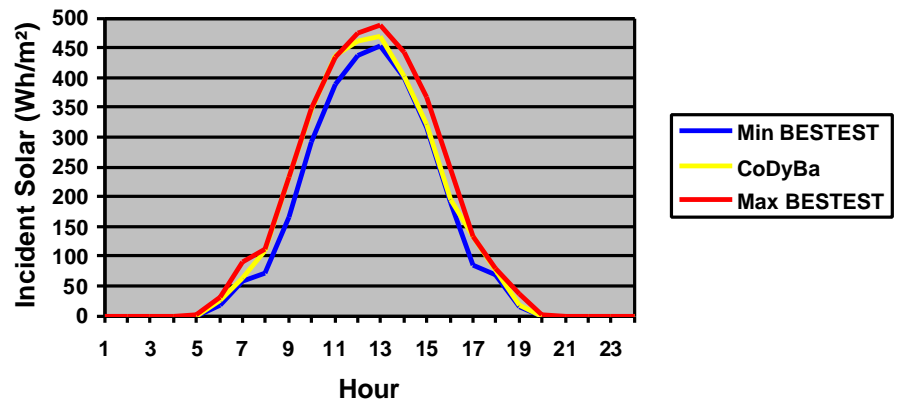
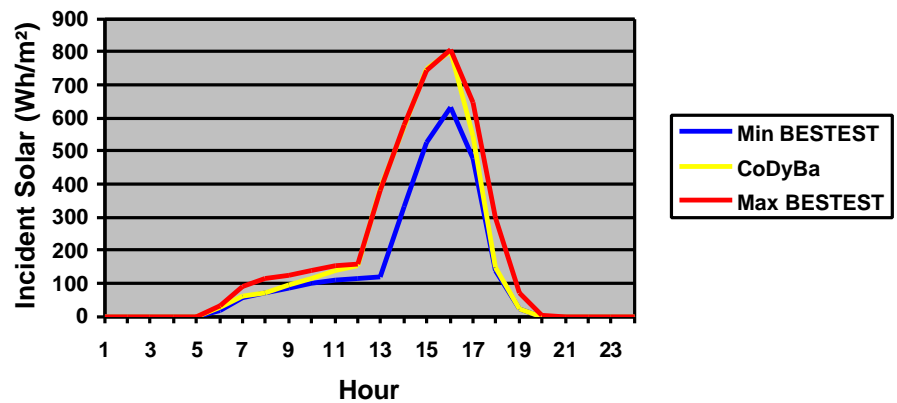

Fig. R20 : incident solar flux density, clear day, west surface



All CoDyBa results are globally within BESTEST range.

V - 2 - 9 - 2 - Case 900FF : hourly Free Float temperature

Hour	Clear cold day (4 th of January)						Clear hot day (27 th of July)					
	Case 600FF			Case 900FF			Case 650FF			Case 950FF		
	MinB	MaxB	CDB	MinB	MaxB	CDB	MinB	MaxB	CDB	MinB	MaxB	CDB
1	-13,04	-8,88	-12,68	-3,46	1,61	-0,94	21,80	22,69	22,5	24,20	25,51	24,77
2	-14,59	-10,48	-14,13	-3,99	0,93	-1,54	20,80	21,33	21,25	23,46	24,74	24,03
3	-15,65	-11,76	-15,14	-4,40	0,49	-1,98	19,90	20,41	20,34	22,86	24,07	23,43
4	-16,46	-12,75	-16,02	-4,80	0,07	-2,44	19,10	19,61	19,52	22,27	23,39	22,79
5	-17,16	-13,69	-16,78	-5,22	-0,41	-2,90	18,80	19,29	19,15	21,86	22,96	22,46
6	-17,9	-14,49	-17,43	-5,60	-0,87	-3,35	19,24	19,91	19,77	22,01	23,08	22,77
7	-18,5	-15,15	-17,99	-5,98	-1,27	-3,78	21,16	22,53	22,28	23,32	24,73	24,39
8	-18,8	-15,63	-18,05	-6,08	-1,64	-4,12	23,47	25,03	24,11	25,62	27,59	26,29
9	-15,47	-13,46	-14,73	-4,72	-1,54	-3,55	25,67	28,33	27,11	26,81	29,42	27,22
10	-10,03	-7,099	-9,10	-2,98	-0,40	-2,40	28,91	32,42	30,86	27,79	30,68	28,15
11	-2,2	3,657	0,65	0,25	1,66	-0,20	32,80	37,12	35,24	28,96	31,98	29,2
12	8,84	13,49	9,84	2,54	4,40	1,74	37,49	42,08	39,62	30,31	33,56	30,32
13	18,75	22,3	17,72	4,38	6,72	3,43	41,94	46,46	43,45	31,54	34,79	31,29
14	25,48	29,82	24,2	5,85	8,66	5,02	45,43	49,69	46,05	32,52	35,65	32,04
15	29,21	34,69	27,62	6,61	10,02	5,87	47,40	51,45	47,43	33,08	35,96	32,52
16	28,97	35,51	27,45	6,33	10,40	5,96	47,33	51,73	47,75	33,22	35,82	32,79
17	22,58	31,46	21,39	4,20	9,41	4,73	46,71	50,74	47,53	33,18	35,61	32,96
18	15,59	23,99	15,5	2,45	7,66	3,69	45,28	48,81	45,85	32,94	34,93	32,69
19	10,2	18,08	10,62	1,71	6,74	3,02	33,10	37,60	34,71	30,00	30,96	30,23
20	6,02	13,02	6,62	1,32	6,00	2,52	30,49	32,09	31,4	29,10	29,97	29,41
21	2,39	8,87	3,07	0,82	5,41	1,98	28,50	29,20	29,09	27,64	29,17	28,62
22	-0,59	5,12	0,17	0,42	4,74	1,54	26,30	26,92	26,8	27,10	28,15	27,48
23	-3,04	2,03	-2,24	0,05	4,20	1,13	25,40	25,90	25,82	26,62	27,72	27,18
24	-5,14	-1,03	-4,33	-0,34	3,66	0,70	23,70	24,26	24,2	25,54	26,74	26,14

Table V : hourly Free Float temperatures

Fig. R21 : case 600FF, clear cold day, hourly free-float temperatures

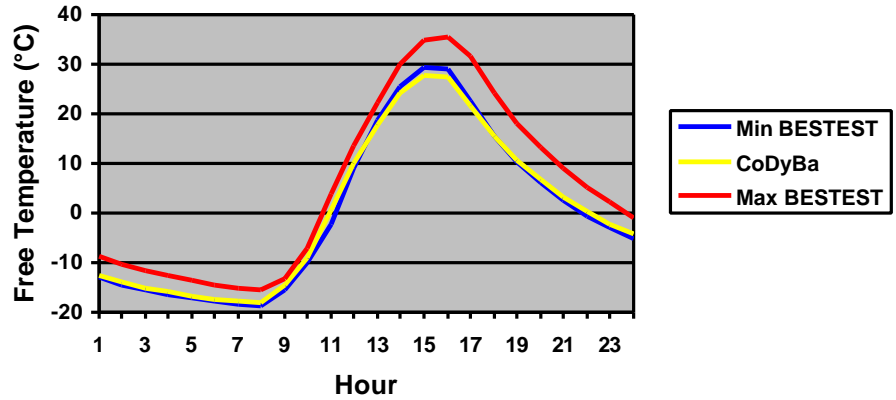

Fig. R22 : case 900FF, clear cold day, hourly free-float temperatures

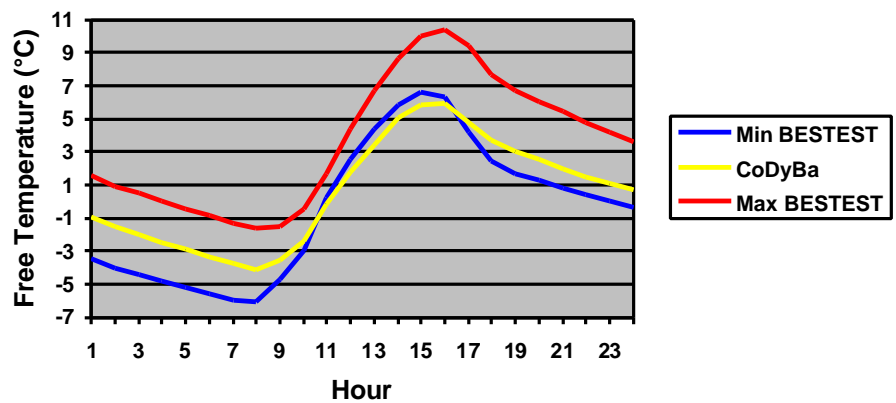

Fig. R23 : case 650FF, clear hot day, hourly free-float temperatures

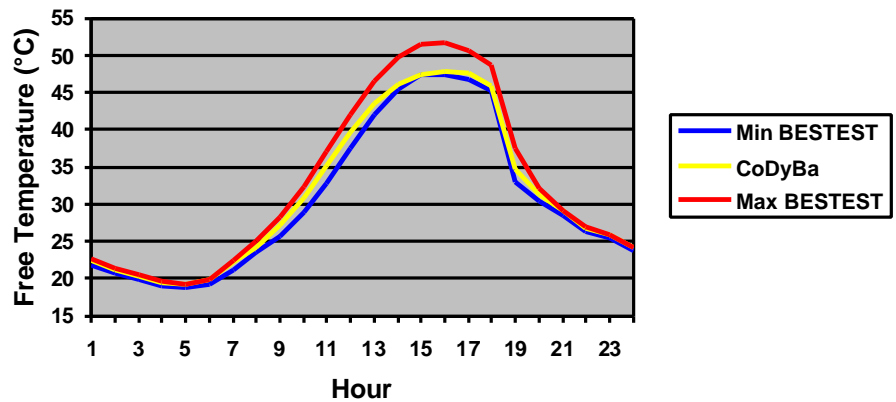
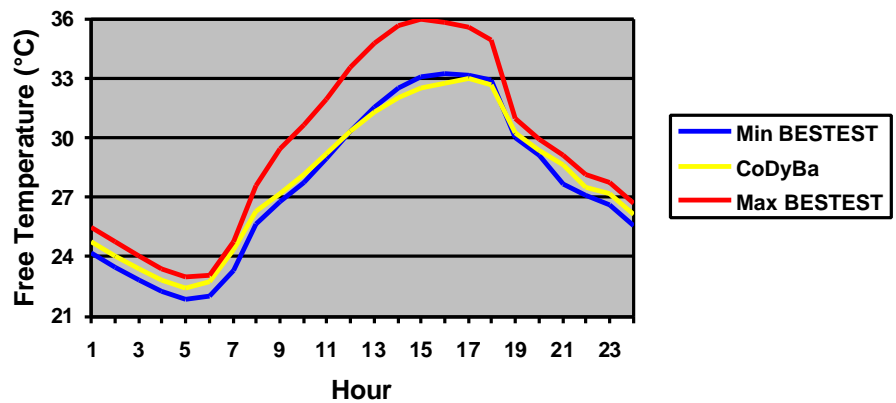

Fig. R24 : case 950FF, clear hot day, hourly free-float temperatures



All CoDyBa results are globally within BESTEST range.

V - 2 - 10 - BESTEST Qualifications : Hourly Loads

Hour	4 th of January					
	Case 600			Case 900		
	MinB	MaxB	CDB	MinB	MaxB	CDB
1	3,250	4,225	3,966	2,441	3,737	3,278
2	3,409	4,354	4,074	2,606	3,896	3,427
3	3,392	4,321	4,037	2,623	3,914	3,470
4	3,381	4,308	4,031	2,667	3,965	3,535
5	3,417	4,303	4,030	2,744	4,011	3,595
6	3,432	4,307	4,030	2,800	4,050	3,649
7	3,421	4,307	4,031	2,834	4,081	3,695
8	3,337	4,167	3,873	2,837	4,018	3,687
9	2,361	2,912	2,553	2,641	3,170	3,184
10	0,326	1,497	0,967	1,805	2,449	2,455
11	-0,147	0,151	0	0,108	1,502	1,254
12	-2,986	-0,424	-1,073	0	0,676	0,380
13	-4,123	-2,364	-2,449	0	0,136	0
14	-4,250	-2,759	-2,965	0	0	0
15	-3,527	-2,431	-2,439	0	0	0
16	-2,435	-1,140	-1,095	0	0,088	0
17	-0,356	0	0	0	1,198	0
18	0,243	1,757	1,255	0	1,602	0,737
19	1,530	3,382	2,555	0,258	1,805	1,170
20	2,321	3,678	3,076	0,995	1,943	1,469
21	2,641	3,818	3,392	1,269	2,121	1,771
22	2,899	3,824	3,499	1,502	2,227	1,983
23	3,017	3,786	3,533	1,658	2,338	2,164
24	3,008	3,778	3,562	1,749	2,545	2,338

Table W : Hourly Loads

Fig. R25 : Case 600, clear cold day, hourly loads

Heating(+), Cooling(-)

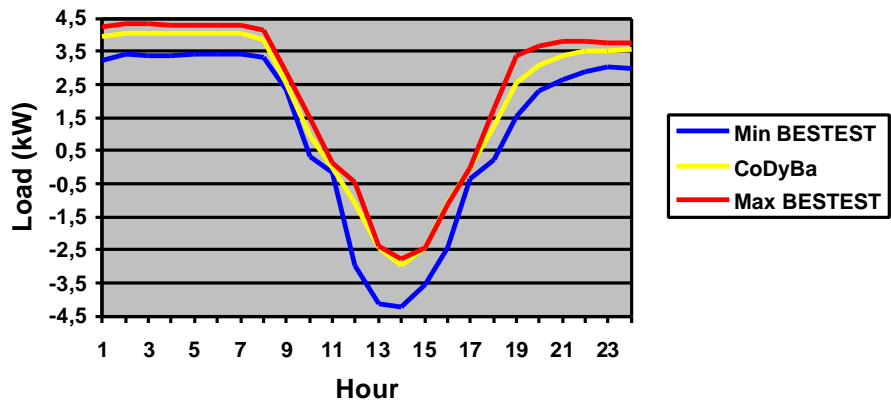
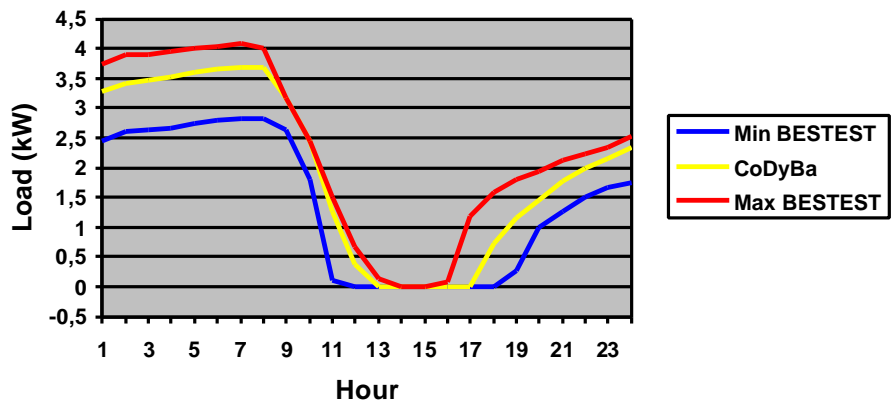

Fig. R26 : Case 900, clear cold day, hourly loads



V - 2 - 11 - BESTEST Qualifications : Case 900FF Annual Hourly Temperature Frequency

The occurrence frequencies of temperature values over a year are presented in the next table.

°C	BR Min	BR Max	CDB
-14	0	0	0
-13	0	0	0
-12	0	0	0
-11	0	0	0
-10	0	0	0
-9	0	0	0
-8	0	0	0
-7	0	1	0
-6	0	3	0
-5	0	4	0
-4	0	6	0
-3	0	7	3
-2	3	12	2
-1	3	18	8
0	8	20	21
1	6	20	15
2	13	20	19
3	15	25	17
4	14	24	21
5	18	30	26
6	19	35	33
7	28	45	26
8	30	59	44
9	42	73	60
10	51	118	65
11	67	134	92
12	90	139	130
13	115	173	148
14	151	183	171
15	165	234	197
16	195	274	217
17	244	298	278
18	266	350	315
19	317	356	351
20	331	387	386
21	334	398	376
22	329	385	362
23	341	396	359
24	338	401	347
25	357	432	392
26	373	455	422
27	396	465	420
28	390	463	427
29	391	459	386
30	362	422	394
31	335	406	351
32	322	369	310
33	291	339	330
34	242	321	308
35	197	303	264
36	169	254	218
37	136	195	163
38	92	175	139
39	71	112	85
40	35	90	40
41	15	58	19
42	0	36	4
43	0	18	0
44	0	5	0
45	0	0	0
46	0	0	0
47	0	0	0
48	0	0	0
49	0	0	0
50	0	0	0

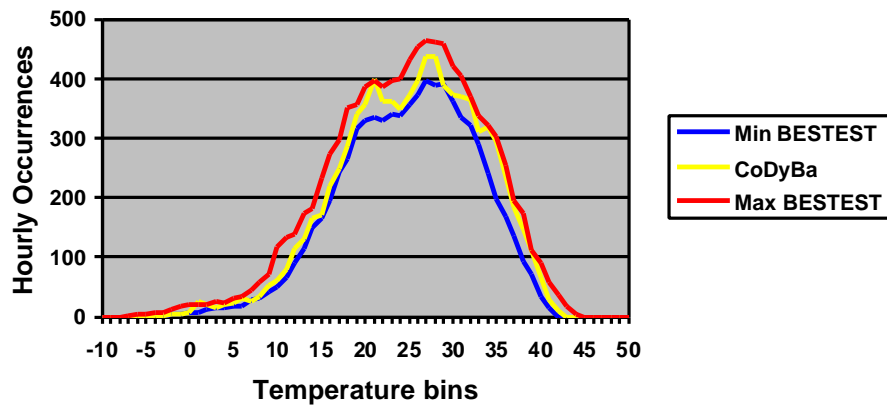

Fig. R27 : hourly occurrences for each 1 °C bin

Table X : temperature bins

The temperature values in the range [$T_0 - 0.5$ °C , $T_0 + 0.5$ °C] are assigned to T_0 .

V - 3 - BESTEST Diagnostics Cases

Fig. R28 : Annual Heating

One failure : for case 810, the annual cooling predicted by CoDyBa is without the range of spread.

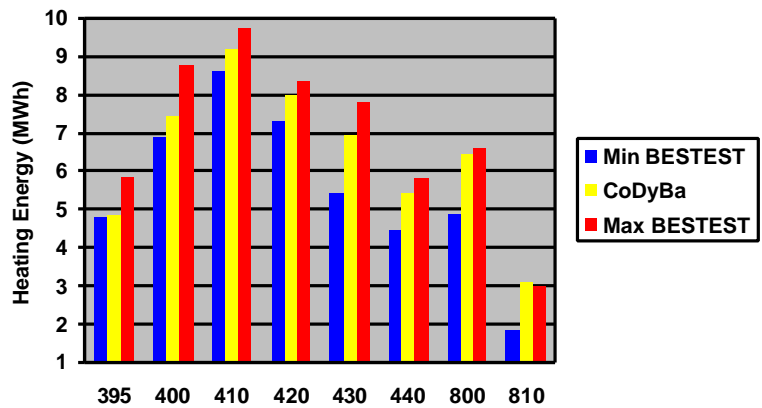

Fig. R29 : Annual Cooling

One failure : for case 440, the annual cooling predicted by CoDyBa is without the range of spread.

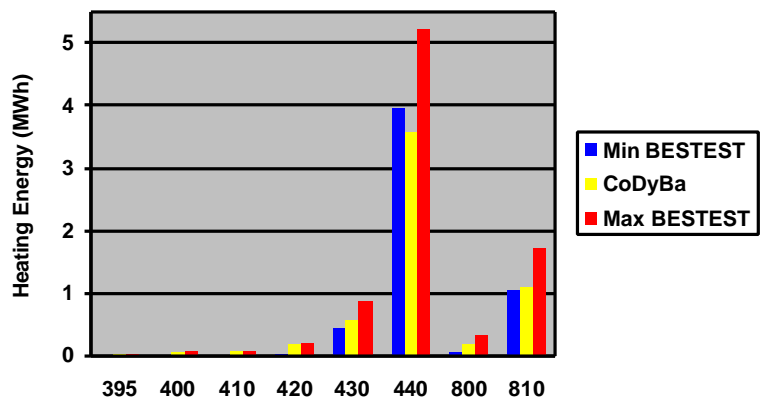

Fig. R30 : Peak Heating

All CoDyBa results are within BESTEST range.

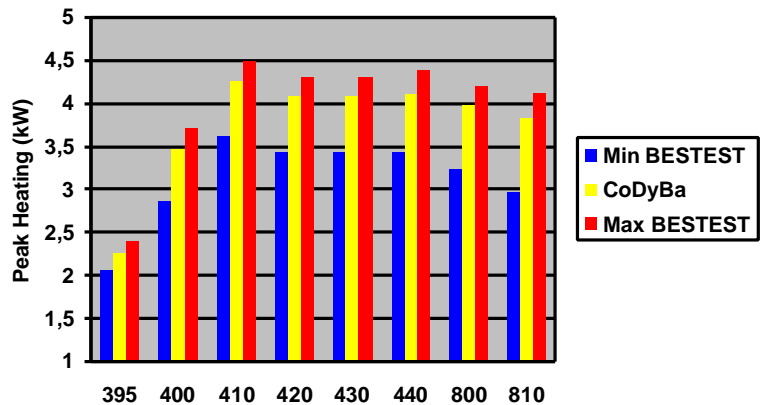
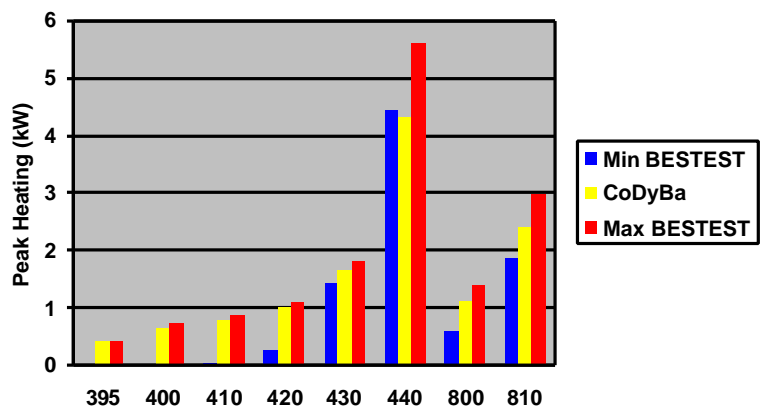

Fig. R31 : Peak Cooling

One failure : for case 440, the peak cooling predicted by CoDyBa is without the range of spread.



VI - Conclusions

VI - 1 - Conclusions

CoDyBa Version 6.4 was used to model a range of building specifications as specified in BESTEST Report : the results obtained by CoDyBa are in very good agreement with those found by other classical softwares.

For the 50 qualification individual comparisons (see Table V-1-1) that were performed, the CoDyBa results were within the range of spread of results for the reference programs for all cases except the following :

- Case 630, Low Mass Building with east and west overhangs and fins, Peak Cooling
- Case 910, High Mass Building with south overhang, Annual Heating
- Case 930, High Mass Building with east and west overhangs and fins, Peak Cooling
- Case 940, High Mass Building with thermostat setback, Peak Heating
- For the free floating cases, the maximum and minimum zone temperatures predicted by CoDyBa were within the range of spread for all programs except for : case 600FF (maximum zone temperature), case 650FF (maximum zone temperature), case 600FF (maximum and average zone temperatures)

Concluding remarks :

Flux transmitted by south and west glazing also show that the yearly flux transmitted by the glazing and the transmission coefficient are comparable with those of the other codes.

Consumption : the hourly consumption curves for the 4th of January agree fairly well with the reference results and make one suppose that there are no major problems regarding the thermal dynamics.

Minimum free-float temperatures from cases 600FF and 900FF tend to be at the low end of the reference results, especially in the high-mass (900FF) where the temperature is about 1 °C less than the next lowest result. This remark is also made in SCIAQ qualification report (see [SCIAQ]).

An area of discrepancy may be observed for solar radiation : it seems that the model of sky has a great importance on the solar flows received by the walls. One can observe an unquestionable dispersion on the values obtained by reference programs, what leads naturally to a dispersion on results for cases where the solar fluxes transmitted by the windows are important. This is why it is necessary to relativize the variations of results obtained by CoDyBa whenever are present solar masks.

VI - 2 - Final conclusion

A program may be thought of as having passed successfully through the qualification (see BESTEST Report 1.3) series when its result compare favourably with the reference program output for both the qualification cases (600 and 900 series).

Considering the results obtained by CoDyBa, one can consider that the software is on the level of the reference programs.

VII - Bibliography

- [BR] BESTEST Report
"International Energy Agency Building energy Simulation Test (BESTET) and diagnostic Method."
JUDKOFF, R., and NEYMARK J.
NREL/TP-472-6231. Golden, CO: National Renewable Energy Laboratory.
<http://www.nrel.gov/docs/legosti/old/6231.pdf>
- [CDB] CODYBA, a design tool for buildings performance simulation
J. Noel, J.-J. Roux, P. S. Schneider
Building Simulation 2001, Rio de Janeiro, Brazil, August 13-15, 2001
- [CET] <http://cethil.insa-lyon.fr/>
- [JNS] <http://jnsoft.chez.tiscali.fr>
- [HEED] "HEED validated against the ASHRAE/BESTEST Standard"
G. TSAL and M. MILNE
UCLA Department of Architecture and Urban Design
http://www2.aud.ucla.edu/heed/binaries/HEED_BESTTEST.pdf
- [S140] ANSI/ASHRAE Standard 140-2001
"Standard method of test for the evaluation for building energy analysis computer programs"
(2001)
Atlanta, GA ; American Society of Heating, Refrigerating and Air-Conditioning Engineers
- [SCIAQ] " Evaluation of SCIAQ Professional with BESTEST "
Techno Consult AS
http://www.programbyggerne.no/besttest_report.htm

Appendix : summary of validation procedure proposed by CEN Pr EN13791

This procedure requires the evaluation of the internal air temperature of the room specified below at several time intervals.

I - Test data

Characteristics of the room :

- internal dimensions 1m x 1m x 1m
- each wall including ceiling and floor have the same boundary conditions
- the short-wave radiative heat transfer is assumed to be zero
- the air flow rate due to the ventilation is assumed to be zero
- the internal convective heat transfer coefficient of each wall including ceiling and floor is $h_i = 2,5 \text{ W/m}^2 \cdot \text{K}$
- the external convective heat transfer coefficient of each wall including ceiling and floor is $h_e = 8 \text{ W/m}^2 \cdot \text{K}$
- the emissivities of the internal and external surface of each wall including ceiling and floor are assumed to be zero (the long-wave radiative heat transfer at inside and outside are assumed zero)
- the thermal capacity of the internal air is assumed to be zero

Boundary conditions :

- the outdoor air temperature is variable according to Figure 1 : $t \leq 0$: $\theta_e = 20 \text{ }^\circ\text{C}$; for $0 < t \leq 1$ (hour): linear variation of the outdoor temperature θ_e from $20 \text{ }^\circ\text{C}$ to $30 \text{ }^\circ\text{C}$; $t > 1$ hour: $\theta_e = 30 \text{ }^\circ\text{C}$;
- the internal air temperature θ_i is constant at $20 \text{ }^\circ\text{C}$ for $t \leq 0$.

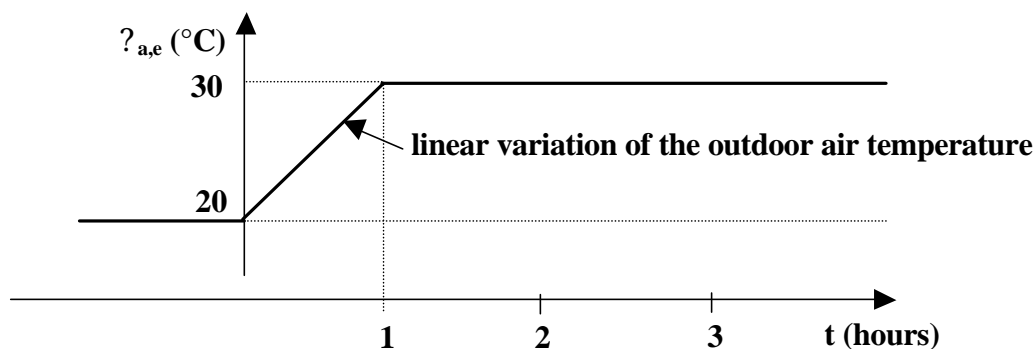

Figure 1 : Variation of the outdoor air temperature

Test conditions : Tests shall be conducted for the envelope elements given in Table 1.

Test n°	Thickness s [m]	Thermal conductivity λ [W/(m · K)]	Density ρ [kg/ m ³]	Specific heat capacity C [kJ/(kg · K)]
1	0,20	1,2	2000	1,0
2	0,10	0,04	50	1,0
	0,20	1,2	2000	1,0
3(*)	0,10	0,04	50	1,0
	0,005	0,14	800	1,5
	0,005	0,14	800	1,5
4(*)	0,10	0,04	50	1,0
	0,20	1,2	2000	1,0

(*) layers from outside to inside

Table 1 : characteristics of the envelope components

Data to be calculated :

The internal air temperature shall be determined after the following times: 2, 6, 12, 24 and 120 hours.

Expected results :

Test n°	2h	6h	12h	24h	120h
1	20,04	21,26	23,48	26,37	30,00
2	25,09	29,63	30,00	30,00	30,00
3	20,00	20,26	21,67	24,90	29,95
4	20,00	20,06	20,25	20,63	23,17

Table 2 : reference values of the internal air temperature (°C)

For each test, the differences between the values of the internal air temperature, for each time considered, shall be less than 0,5 K from those given in Table 7.

II - Test results

Test n°		2h	6h	12h	24h	120h	Delta
1	CoDyBa	20,31	21,49	23,45	26,32	29,97	0,27
	analytical	20,04	21,26	23,48	26,37	30,00	
2	CoDyBa	25,55	29,09	29,84	30	30	0,54
	analytical	25,09	29,63	30,00	30,00	30,00	
3	CoDyBa	20,12	20,69	21,97	24,69	29,94	0,30
	analytical	20,00	20,26	21,67	24,90	29,95	
4	CoDyBa	20,04	20,17	20,36	20,73	23,22	0,11
	analytical	20,00	20,06	20,25	20,63	23,17	

Table 3 : CoDyBa results summary

III - Conclusions

The norm requires that "for each test, the differences between the values of the internal air temperature, for each time considered, shall be less than 0,5 K from those given in Table 3". One can note that it is practically the case for all the tests, except for which the value is slightly higher.

However the requirement by the norm of a lower deviation than 0.5 is not justified in the CEN report. Indeed, why a value of 0.5 and not of 0.25 or 0.75? Why does this value lead to a better thermal evaluation of a building?

The benchmark BESTEST on the contrary do not give a value limiting to the noted result variations. The validation or not of the test is left with the appreciation of the developers of software: that appears to us to show of more than flexibility and less dogmatism.